

JVC

SERVICE MANUAL

CASSETTE RECEIVER

KS-RT626 C/J

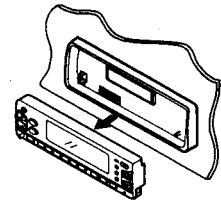
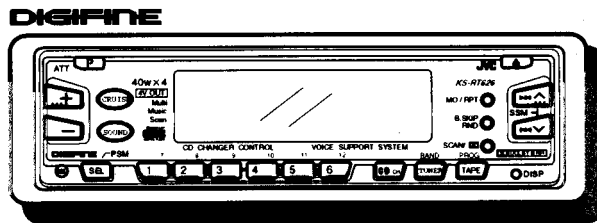

Area Suffix

c..... Canada
 J..... U.S.A

Contents

■ Instructions.....	Page 2	7 Location of P. C. Board Parts and Parts List.....	66
1 Location of Main Parts.....	46	8 Exploded View of Enclosure Assembly	
2 Removal of Main Parts.....	48	and Parts List	74
3 Main Adjustments.....	55	9 Exploded View of Mechanism Assembly	
4 Wiring Connections	58	and Parts List	76
5 Block Diagram.....	59	10 Illustration of Packing and Parts List.....	79
6 Standard Schematic Diagram.....	63		

CAUTION

Burrs formed during molding may be left over on some parts of the chassis. Therefore, pay attention to such burrs in the case of performing repair of this system.

2. Instructions

Thank you for purchasing a JVC product. Please read all instructions carefully before operation, to ensure your complete understanding and to obtain a longer service life from the unit.

CONTENTS

RADIO OPERATION	4
Listening to the radio	4
Storing the stations in memory automatically	5
Strong-station sequential memory (SSM)	6
Manual station preset	7
Receiving the preset stations	8
Preset station tuning	8
When an FM stereo broadcast is noisy	8
Mono button	8
Using this unit in an area other than North or South America	8
To change the intervals between channels	8
TAPE OPERATION	9
Listening to a tape	9
For use as long as possible	12
Cleaning the head	12
Tape care hints	12
REMOTE CONTROLLER	12
CLOCK ADJUSTMENT	13
OTHER FUNCTIONS	14
Selecting the desired source with the power off	14
One touch operation	14
Adjusting the sound characteristics	14
Audio level control	14
Selecting the sound characteristics suitable to the music genre	15
Changing the sound setting as required	16
Sound control memory (user preset)	17
Setting each mode to suit your needs	17
Preferred setting mode (PSM) control	17
Controlling the volume automatically according to the driving speed of the car	18
Audio Cruise Mode	18
Using voice or beep sounds to confirm operations	21
Voice Support System	21

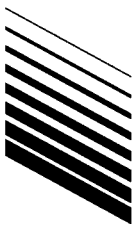

JVC

CASSETTE RECEIVER

KS-RT626

RECEPTOR-REPRODUCTOR DE CASSETTE

KS-RT626

RADIOCASSETTE

KS-RT626

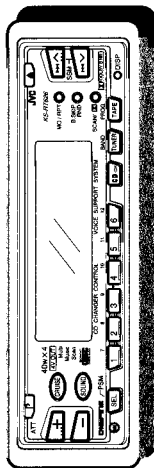
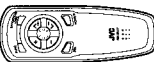

For installation and connections, refer to the separate manual.
Para la instalación y las conexiones, refiérase al manual independiente.
Pour l'installation et les raccords, se référer au manuel séparé.

For Customer Use:
Enter below the Model No. and Serial No. which are located on the top or bottom of the cabinet. Retain this information for future reference.

Model No. _____
Serial No. _____

INSTRUCTIONS
MANUAL DE INSTRUCCIONES
MANUEL D'INSTRUCTIONS

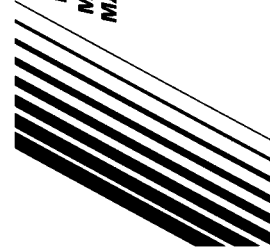

J version

- When leaving the car
- How to detach the control panel 22
- How to attach the control panel 22

Using the other equipment

CD CHANGER OPERATION 23

- Playing all tracks 23
- Playing compact discs 23
- Selecting a disc 24
- Disc selection 24
- Skipping to the beginning of a track 24
- Skip playback 24
- Locating a required position on the disc 25
- Search playback 25
- Playing back tracks at random 25
- Random playback 25
- Playing back a track repeatedly 25
- Repeat playback 25



TROUBLESHOOTING 26



SPECIFICATIONS 27

BEFORE USE

- * For safety ...
 - Do not raise the volume level too much, as this will block outside sounds, making driving dangerous.
 - Stop the car before performing any complicated operations.
- * Temperature inside of the car...
 - If the car has been parked for a long time in hot or cold weather, wait until the temperature in the car becomes normal before operating the unit.

RADIO OPERATION

Listening to the radio

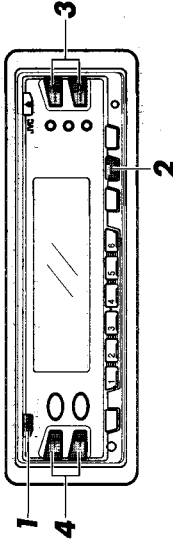

1 ATT Switch on.

2 BAND/TUNER FM 1 → FM 2 → FM 3 → AM Select the band.

FM1, FM2, FM3 have the same frequency range and up to 6 stations can be preset in each band.

3 Press to seek up. Tune. Use manual or seek tuning to find a station. (See page 7.) Press to seek down.

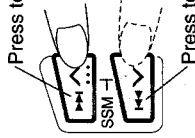

4 Adjust volume.

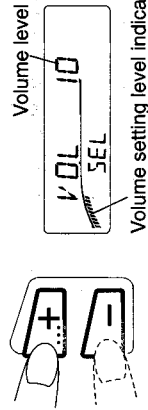

Volume level
Volume setting level indicator (See page 17.)

Note: Power (P)/Attenuator (ATT) button. When this button is pressed during operation, the volume drops and the ATT indicator blinks. Press again to return to the original volume.
Power (P): Press to turn the power ON. Press for more than 1 second to turn the power OFF.
ATT:

Storing the stations in memory automatically

Strong-Station Sequential Memory (SSM)

This function searches for FM stations broadcasting strong signals. The 6 strongest stations are held in memory in the order of increasing frequency, and can be recalled with the Preset station buttons No. 1 to No. 6.

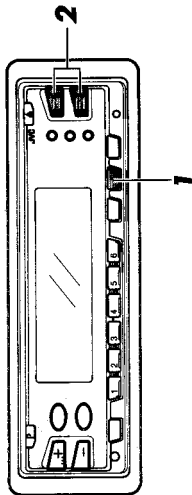

1 Select the band.
(FM1, FM2 or FM3)

2 Press the SSM buttons (SSM) together for more than 3 seconds.

- The strongest signals in the band you are listening to (FM1, FM2 or FM3) will be searched and selected automatically. Six stations are preset in the Preset station buttons (No. 1 to No. 6) in the order of increasing frequency. (During this operation, "SSM" lights in the display.) The unit then automatically tunes to the broadcast stored in Preset station button "1".

Storing the desired stations in memory

Manual Station Preset

You can preset up to 6 stations in each band (FM1, FM2, FM3 and AM) as follows:

- Example (when presetting Preset station button "1" of the FM1 band to an FM station at 88.3 MHz)

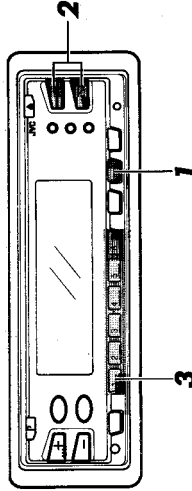

1 Select the FM1 band using the Band (BAND) button.

2 Use manual or seek tuning to find a station that you want to store in memory. (See page 7.)

3 Press Preset station button "1" for more than 2 seconds. (When "MEMO" blinks in the Preset station display, the station is preset.)

- Repeat the above procedure for the other 5 Preset station buttons and other bands (FM2, FM3 and AM).

Notes:

- A previously preset station is erased when a new station is stored in memory.
- The preset stations are erased when the power supply to the memory circuit is interrupted during battery replacement, etc. When this occurs, preset the stations again.

ENGLISH

Receiving the preset stations

Preset Station Tuning

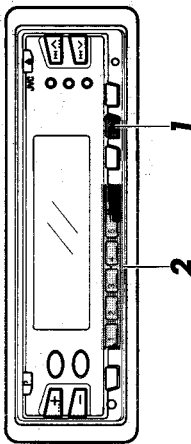

1 BAND TUNER FM 1 → FM 2 → FM 3 → AM Select the band.

2 Press the required Preset station buttons (No. 1 to No. 6).

ENGLISH

When an FM stereo broadcast is noisy

Mono Button

Set to MONO mode when a stereo FM broadcast is too noisy and cannot be heard satisfactorily.

Antenna Noise

If you can hear static noise when listening to either AM or FM, check for loose antenna connections.

Using this unit in an area other than North or South America

To Change The Intervals Between Channels

When this unit is purchased, the channel intervals are set to 10 kHz for AM and 200 kHz for FM. If the unit is used in an area other than North or South America, adjust as follows:

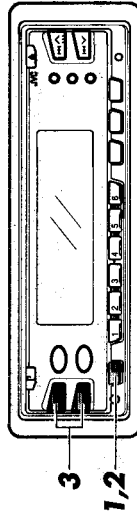

Manual Tuning

To set the Manual mode, press and hold the tuning button (or). The "MANU" indicator blinks. Press the tuning button to tune to the desired frequency.

Frequency scan steps are as follows:

FM — in 200 kHz (or 50 kHz) units

AM — in 10 kHz (or 9 kHz) units

• About 5 seconds after completing manual tuning, the unit switches back to Seek mode and the "MANU" indicator goes out.

Seek Tuning

Press the or button; the unit tunes to higher or lower frequencies. When a broadcast is received, tuning stops automatically and the broadcast can be heard.

Scan Tuning

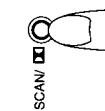

When the Scan button is pressed, automatic scanning starts towards the higher frequencies. Each time a broadcast is received, the displayed frequency blinks and it is monitored for approx. 5 seconds. If you want to listen to the tuned frequency, press the Scan button again to turn automatic scanning off.

1 SEL CLK PSM Press the PSM button for more than 2 seconds.

2 SEL AREA PSM AREA 1 PSM Select the "AREA" mode.

3 SEL AREA 2 PSM Set the "AREA 2" mode.

- Performing this procedure sets the channel intervals to 9 kHz for AM and 50 kHz (Manual mode), 100 kHz (Seek mode) for FM.
- To change back to the original intervals, repeat the above procedures. In procedure 3, press the "-" button to set to the "AREA 1" mode.

TAPE OPERATION

Listening to a tape

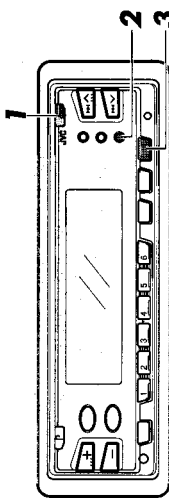

1 Insert a cassette.

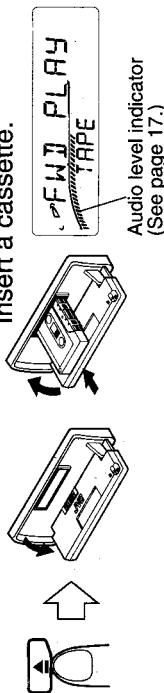

2 Set the Dolby B NR (DR) button as required.

3 Select program (tape direction).

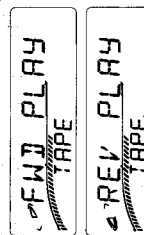

Notes:

- Do not touch the highly-polished head with any metallic or magnetic tools.
- Never play dirty or dusty tapes since they will greatly degrade the sound and performance of your unit. Always keep your tapes clean.
- Cassettes can be inserted/ejected even when the power is OFF.

- DOLBY B NR button
Set the Dolby B NR (DR) button as required.
ON — (DR) indicator lights.
OFF — (DR) indicator goes out.

* Dolby Noise reduction manufactured under license from Dolby Laboratories Licensing Corporation. "Dolby" and the double-D symbol DR are trademarks of Dolby Laboratories Licensing Corporation.

ENGLISH



Loading Tapes

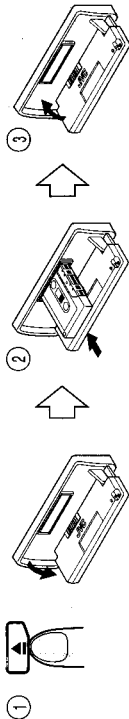

- 1 Open the control panel by pressing the (▲) button.
 - 2 Insert a cassette tape into the loading slot. (When the tape is inserted part-way, it is drawn in and play starts automatically.)
 - 3 Close the control panel by hand.
- * The buttons don't function for 2 seconds after closing the control panel.

Unloading Tapes

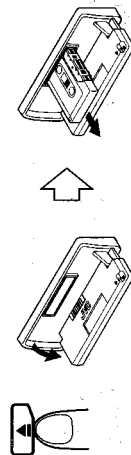

To unload a tape, press the (▲) button; control panel is opened. The tape pops out allowing tape removal.

Note:
• Tape loading/unloading is possible even after the vehicle's ignition is turned OFF.

* **Tape eject prohibit mode**
Even if the (▲) button is pressed while the unit is in this mode, it is impossible to take out a tape.
To engage this mode, while pressing the TAPE button, press the (P) button for 2 seconds or more. The "EJECT" blinks when this function is effective. To release this function, repeat the procedure above. The "EJECT" blinks, showing that the tape can be taken out.

Ignition Key-Off Release (Key-On Play) Mechanism

When the ignition key is turned OFF, the "key-off release" mechanism automatically releases the tape from the magnetic head, then enters Standby mode. When the ignition is turned ON, Playback mode automatically restarts.

Auto-Reverse Mechanism

When the tape reaches its end, this mechanism automatically switches over to play back the other side. To listen to the other side of the tape during playback, press the PROG button. The change in direction can be checked in the Tape direction indicator.

Auto Tape Select Mechanism

This unit has an Auto Tapes Select mechanism which distinguishes between different types of tapes. When the type is detected, equalization is set to its most suitable level.

How To Fast-Forward And Rewind Tapes

Press the ► button for more than 1 second to fast-forward the side being played; when the tape end is detected, the tape is reversed and playback starts from the beginning of the other side. Press the ◀ button for more than 1 second to rewind the tape to its beginning, where playback restarts.

For use as long as possible

Cleaning The Head

- Head cleaning tape
- Heads are important as they pick up sound. When they become dirty, the following symptoms become noticeable:
- The sound quality is reduced.
 - The sound level is decreased.
 - The sound can be heard intermittently. (Sound drop occurs.)

These are NOT malfunctions. However, before these symptoms appear, clean the heads after every 10 hours of use using a wet-type head cleaning tape, available from an audio store. For more details, refer to the Instructions of the Head Cleaning Tape.

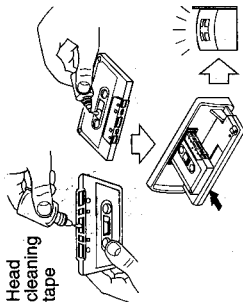

Tape Care Hints

It is very important to keep your tapes clean. Always return them to their storage boxes after playback. Never store tapes in direct sunlight, high humidity or extremely hot temperatures. Never play dirty, dusty tapes or the tapes with peeling labels—they can damage the unit. Slack tape in a cassette can cause trouble by becoming entangled with the mechanism.

- Always remove cassettes from the loading slot when not listening to them, as the tape may become slack.

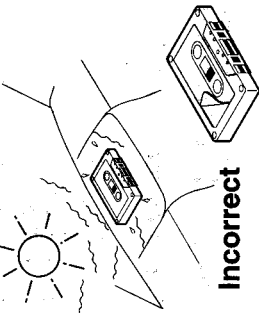

Incorrect

Note: Your unit requires very little attention, but you will be assured of top performance only if you follow above notes.

REMOTE CONTROLLER

The following operations can be performed using the remote controller.

- Check the functions of the operation buttons carefully and operate them correctly.

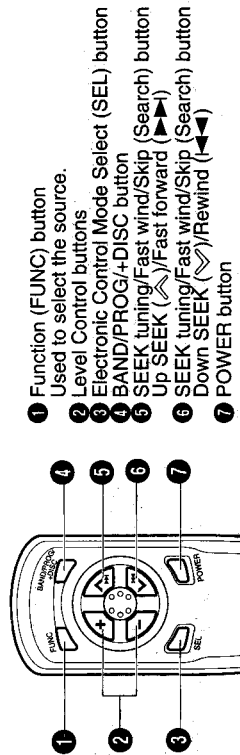

- 1 Function (FUNC) button
- 2 Used to select the source.
- 3 Level Control buttons
- 4 BAND/PROG/+DISC button
- 5 SEEK tuning/Fast wind/Skip Up SEEK (↗)/Fast forward (▶▶)
- 6 SEEK tuning/Fast wind/Skip (Search) button
- 7 POWER button

ENGLISH

- During scanning, when the tape is rewound to its beginning in Rewind mode, playback starts from the beginning of that side. When the tape reaches its end in Fast-Forward mode, it is reversed and played from the beginning of the other side.

Blank Skip

During playback with this button ON, blank section of more than 15 seconds between tunes are skipped and the tape fast-forwards to the next tune. This operation also functions with auto-reverse, skipping from the end on the other side of the tape.

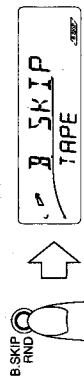

Repeat Function

Press the RPT button while a tune you would like to hear over again is being played back. When the tape reaches the end of the tune, the tape is automatically rewind to the beginning of that tune and playback resumes from there. This operation will be repeated till the RPT button is pressed again.



Note:

In the following cases, the Multi Music Scan, Blank Skip and Repeat function mechanisms may not operate correctly. These are NOT malfunctions; use the mechanisms to suitably accommodate the materials and situations.

- Tapes with tunes having long pianissimo passages (very quiet parts) or non-recorded portions during tunes.
- Tapes with tunes recorded at low recording levels.
- Tapes with short non-recorded sections.
- Tapes with high level noise or humming between tunes.
- The Dolby B NR button settings do not match the tapes NR mode.

Press the PROG button to start playback from the current position during fast-forward or rewind.

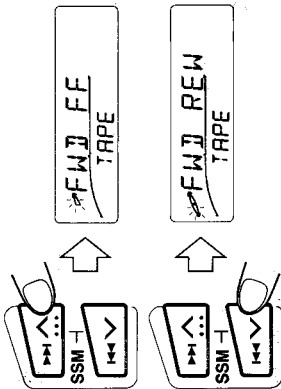

Tuner Call Play

During tape operation, if the ◀◀ or ▶▶ button is pressed for more than 1 second, the unit enters the radio mode automatically and the station to which the unit is tuned will be heard. When the fast forward or rewind mode is canceled, tape play resumes. (If the Music scan preset number indicator is blinking, this operation will not be performed.) This operation may be turned off (refer to "Preferred setting mode (PSM) control" on page 17).

Multi Music Scan Operation

This function enables you to automatically start playback from the beginning of a specified tune (by skipping over a maximum of 9 tunes), in forward or reverse. During play, press the ▶▶ or ◀◀ button once for each tune you wish to skip.

- Example (When skipping forward to the 3rd tune)

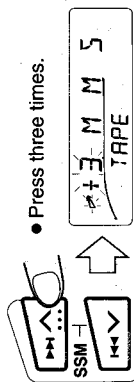

- Press three times.

- When the beginning of the specified tune is detected, the indication number goes out and tape playback starts.

OTHER FUNCTIONS

Selecting the desired source with the power off

One Touch Operation

Even when the power is off, pressing the button shown below switches on the power and selects the source.

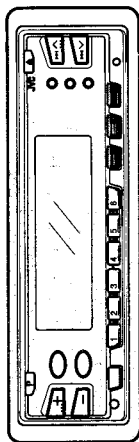

Function mode	Operations
CD	Place a CD in the CD changer connected to this unit and press this button to start CD play.
BAND TUNER	When this button is pressed, the tuner is engaged.
PROG TAPE	When this button is pressed with a tape loaded, tape playback begins.

• Pressing the DISP button switches on the power and after displaying the clock mode for 5 seconds, switches it off.

Adjusting the sound characteristics

Audio Level Control

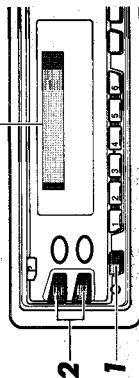

1. Select the control mode with the SEL button.
2. Adjust the level with the level control buttons.

Electronic control mode	Adjust.
VOL	Decreases (00 - 50) Boosts
BAS	Decreases (-06) - (+06) Boosts
TRE	Decreases (-06) - (+06) Boosts
FADJ	Rear (R06 - F06) Front
BAL	Left (L06 - R06) Right
LOUD	off on

ENGLISH



• **Battery replacement**
When the remote controller operation becomes unstable or the distance from which remote controller is possible becomes shorter, replace the batteries with new ones.

• Installing batteries in the remote controller.

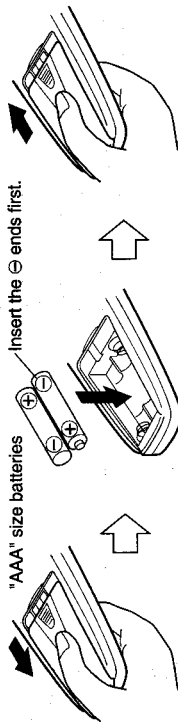

Using The Remote Controller

To use the remote controller, point it at the remote sensor and press the buttons gently and firmly. Do not expose the remote sensor to strong light (direct sunlight or artificial lighting) and make sure that there are no obstacles between the remote sensor and the remote controller.

Remote sensor

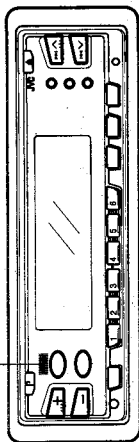

CLOCK ADJUSTMENT

Selecting The Clock Display

Each time the DISP button is pressed, the display is switched between the listening mode and the clock mode.

How to adjust the clock

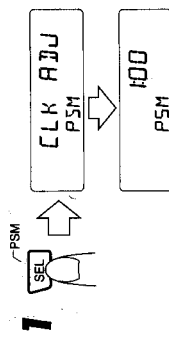

Press the PSM button for more than 2 seconds to select the "CLK ADJ" mode.

- 2
 - Minute
 - Hour

Adjust.
• After adjusting, press the DISP button.



ENGLISH

Fader Control

- When used in a 4-speaker system Use this control to balance the volume levels of the front and rear speakers.
- When used in a 2-speaker system Set this control to the center position ("00" is displayed).

Loudness Control

At low volumes, the human ear is less sensitive to low and high frequencies. When the volume is low, set the loudness control to ON to boost these frequencies and produce well-balanced sound.

Selecting the sound characteristics suitable to the music genre

Sound Control Memory (factory preset)

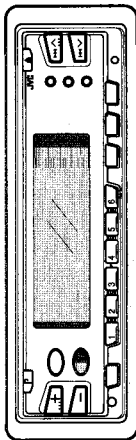

Sound mode	Sound mode icon	Preset level value		
		Bass	Treble	Loudness
SCM OFF	Off (flat characteristics)	00	00	On
BEAT	For music with a heavy beat, such as rock or disco music.	+02	00	On
SOFT	For quiet background music.	+01	-03	Off
POP	For light music including popular and vocal music.	+04	+01	Off



Changing the sound setting as required

Sound Control Memory (user preset)

The Sound mode's preset values can be changed to suit your tastes.
(Example: To emphasize bass sound with beat mode levels 2 to 5.)

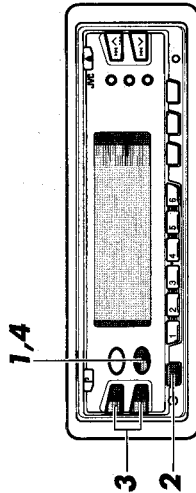

1 Press the SOUND button to select the mode to be changed (Beat, Soft, Pop).

2 Within 5 seconds press the SEL button to select the sound characteristics to be changed (Bass, Treble, Loudness).

3 Within 5 seconds set the desired level with the level control button.

4 Within 5 seconds press the SOUND button to store the set level in memory, and hold it for more than 2 seconds. (The "MEMO" indication blinks when the level has been stored in memory.)

- * To change other preset values, repeat the above procedure.
- * To restore the preset value, repeat the above procedure using the level value for the Sound control memory (factory preset) as a reference.



Controlling the volume automatically according to the driving speed of the car

Audio Cruise Mode

This function detects the alternator's generating frequency and uses it to automatically set the volume level to the most comfortable level (3 possible levels), according to the driving speed of the car.

Setting Cruise Mode

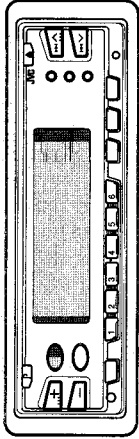

Press the CRUISE button to select the mode.



When CRUISE 1 or CRUISE 2 is selected the indicator lights.



Audio Cruise functions.

- There are many kinds of driving noise. However, if you are driving a car that produces relatively loud noises, use CRUISE 2. (The CRUISE 2 sound volume increases twice as high as CRUISE 1 volume.)
- When AUDIO CRUISE MODE setting is on, the volume level is automatically selected among 1, 2 and 3 according to the speed of engine rotation.



Example: Displays in level 3.

ENGLISH



Setting each mode to suit your needs

Preferred Setting Mode (PSM) Control

The PSM has been set at the factory, but it can be set to suit your needs.

1. Press the PSM button for more than 2 seconds to set the PSM. Press the PSM button to select each mode.
2. Set the desired mode with the level control buttons (+, -).

1 Select.	PSM SEL	2 Set.		Factory-preset settings
		Hour	Minute	
CLK	ADJ	Hour	Minute	1:00
LEVEL	Level	AUDIO ↔ ANTENNA ↔ OFF		AUDIO
VOICE	Voice	VOICE 1 ↔ VOICE 2 ↔ OFF ↕ BEEP 2 ↔ BEEP 1 ↔		VOICE 1
DIMMER	Dimmer	Off	Auto	Auto
AREA	Area	AREA 1	AREA 2	AREA 1
TU CALL	Tuner call	Off	On	On

- LEVEL: Functions as follows:
AUDIO - Audio level indicator
ANTENNA - Displays the sensitivity level of tuner in Tuner mode.
- OFF - Volume setting level indicator
- DIMMER: The Dimmer setting can be set to AUTO/OFF.
- AUTO - When the car head lights are turned on at night, the display window light of the control panel automatically dims.
- OFF - Normal brightness.



**When Audio Cruise Mode doesn't function correctly
How to set the idling speed in memory**

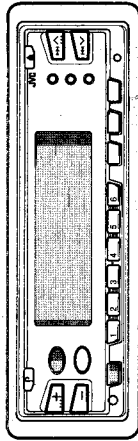

1 Start the engine.
Warm up the engine.

2 Press the CRUISE button to select either CRUISE 1 or CRUISE 2.

3 While the CRUISE button is kept pressed, press the SEL button for more than 2 seconds to store the setting in memory.

After following the above steps, the CRUISE setting is automatically tested. If it doesn't function correctly, CRUISE mode is automatically switched off and the idling speed setting becomes invalid. In this case, please refer the following note.

Note:
A number of factors, such as electric power steering, wipers, power windows, power antennas, air conditioner, etc. may cause the Cruise mode to function incorrectly. In this case, please connect the memory backup lead (yellow) to the battery directly or to a position near the battery to prevent the noise from entering the power supply.



When the increase rate of the sound volume is too much or too little, you can choose the mode settings for your car.

Example: When the rate of increase is too little.

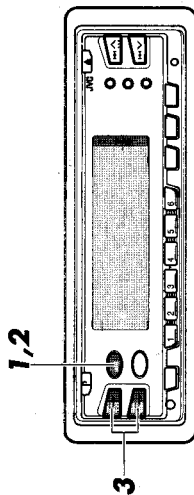

1 Press the CRUISE button to select either CRUISE 1 or CRUISE 2.

2 Press the CRUISE button for more than 2 seconds.
Preset maximum boost level

3 While the maximum boost level is displayed set to the level you desire (from 1 to 15) with level control buttons.

The maximum boost level is reset, and the unit enters the previously engaged mode.

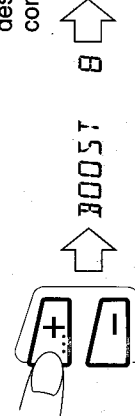

• After changing the setting, please test Audio Cruise operation.



Using voice or beep sounds to confirm operations

Voice Support System

Depending on the setting, this system responds with a voice (in English) or a beep. (For example, when the power is turned on, it says, "HELLO.") Set each mode to suit your needs.

How to select the mode

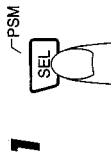
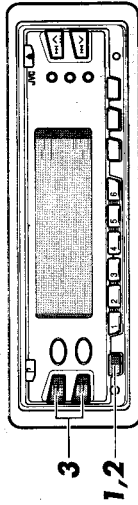

Press the PSM button for more than 2 seconds to set the PSM.

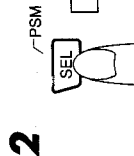

Select the "VOICE" mode.

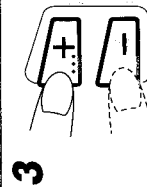

Select.

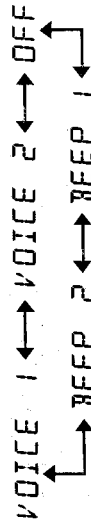

- VOICE 1: Voice level is low.
- VOICE 2: Voice level is high.
- BEEP 1: Beep sound level is low.
- BEEP 2: Beep sound level is high.
- OFF: No sound.

After setting the mode, you can test the voice support system by pressing each operating button.

Notes:

- The voice support system only outputs the sound from the front speakers. If only the rear speakers are used, no sounds will be heard.
- When using this unit with an external amplifier connected, lower the amp's gain control as the voice or beep sound of the voice support system will be louder than usual (than if the amp is not used).

When leaving the car

How To Detach The Control Panel

Before detaching the control panel, be sure to turn off the power.

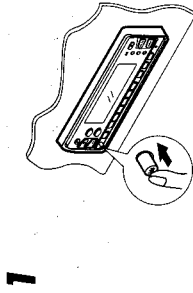

Press the Control Panel Release (⬆) button to detach the control panel.

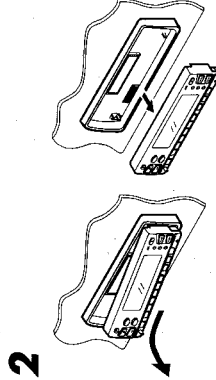

Pull the control panel out of the main unit, as shown.

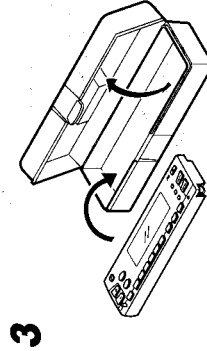

Put the control panel in the provided case for protection.

How To Attach The Control Panel

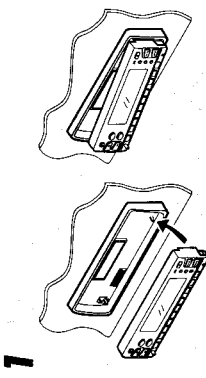

Insert the right side of the control panel into the groove on the right side of the holder.

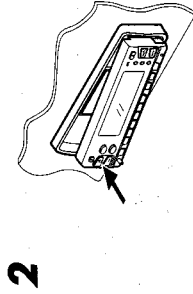

Press the left side to set it correctly.

Cleaning The Connector

If the control panel is frequently detached, a poor connection may occur with the control panel holder. To minimize this possibility, periodically wipe the connector with a cotton swab or cloth moistened with alcohol, being careful not to damage the connector terminals.

Note:

- Be careful not to damage the connector terminals when attaching/detaching the control panel or while the control panel is removed.

CD CHANGER OPERATION

PRECAUTIONS

- This unit is for the control of a JVC CD Automatic Changer (to be purchased separately).
- For correct usage, refer to the Instructions of the CD Automatic Changer.
- When there are no discs in the CD changer's magazine or the discs are inserted upside down, "NO DISC" will be shown in the display. If this happens, remove the magazine and set the discs correctly.
- When "RESET 1 - RESET 8" is shown in the display of the unit, confirm that the cord is connected and press the RESET button of the CD Changer.

Playing all tracks

Playing Compact Discs

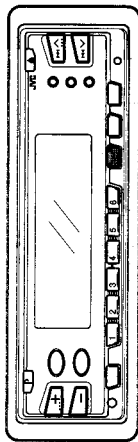

Track number

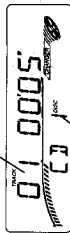
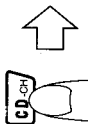

DISC number

Select the CD changer function.

- When all tracks on the first disc have been played, the second disc starts automatically from the first track.



Selecting a disc

Disc Selection

Example: (To specify disc 5)

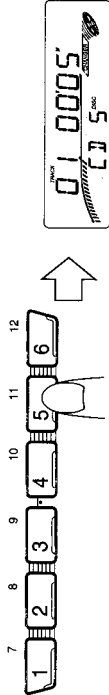

• Direct disc selection

Press the disc number button that corresponds to the desired disc (press it quickly to select No. 1 through No. 6 or for more than 1 second to select No. 7 through No. 12). The disc number and track number light and CD play starts.

• Disc select button (Using the remote controller)

Press the Disc Select button (+ DISC) to select the required disc.

Example: when the third disc is currently playing... Each time the +DISC button is pressed, the 4th, 5th, 6th ... and 1st disc will be selected in sequence.



Skipping to the beginning of a track

Skip Playback

- During playback, you can easily skip to the beginning of the previous, current, or next track, and playback will start again from there.

How to listen to the next track...

Press the (▶▶) button once to skip to the beginning of the next track.

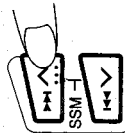

How to listen to the previous track...

Press the (◀◀) button once to skip to the beginning of the current track, then again to skip to the previous track.

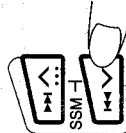

* When Disc Select and Skip operations are performed in sequence, the required track from a designated disc can be selected.



TROUBLESHOOTING

What appears to be trouble is not always serious. First make sure....

Symptoms	Causes	Remedies
* Cassette tape can't be loaded.	It is loaded in the wrong way.	Insert the cassette with the exposed tape facing right.
* Cassette tape gets hot.	This is not a malfunction.	—
* Tape sound is at very low level and sound quality is degraded.	The tape head is dirty.	Clean it regularly with a head cleaning tape.
* Sound is sometimes interrupted.	The cord connection is incorrect.	Confirm the cord connections.
* Sound cannot be heard from the speakers.	The volume control is turned to the minimum level.	Adjust it to the optimum level.
* Auto tuning doesn't work.	The cord connection is incorrect.	Confirm the cord connections.
	Broadcast signal strength is too weak.	Tune to stations manually.
* "NO DISC" is displayed.	CDs aren't set in the magazine. CDs are inserted incorrectly.	Insert CDs into the magazine. Make sure they are correctly inserted.
* "RESET 8" is displayed.	This unit isn't connected to a CD changer correctly.	Connect this unit to it correctly and press the reset button of CD changer.
* "RESET 1—RESET 7" is displayed.	—	Press the reset button of CD changer.
* The unit doesn't function even if any button is pressed.	The built-in microcomputer may function incorrectly due to noise, etc.	Press P (Power) button and SEL button for more than 2 seconds at the same time to reset the unit. (The clock setting and preset stations stored in memory is cancelled and the unit reverts to its initial settings.)

ENGLISH



Locating a required position on the disc

Search Playback

Keep pressed for fast-forward searching.

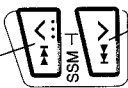

- The required position can be located using fast-forward or reverse search during playback.
- Hold down the button to commence searching. (The search speed increases the longer the button is pressed.)
- Since a low sound level can be heard (approx. one quarter of playback), monitor the sound and release the button when the required position is located.

Keep pressed for fast-reverse searching.

Playing back tracks at random

Random Playback



Each time the RND button is pressed, the mode changes from Random 1 (the RND indicator lights) to Random 2 (the RND indicator blinks) to Clear.

Random 1: Randomly plays all tracks on the current disc once, then on each of the following discs in order.

Random 2: Randomly selects and plays tracks from all of the CDs in the loaded magazine.

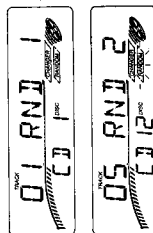

Playing back a track repeatedly

Repeat Playback



Each time the RPT button is pressed, the mode changes from RPT 1 (the RPT indicator lights) to RPT 2 (the RPT indicator blinks) to Clear mode, in this order.

RPT 1: Single track repeat
The current or specified track will be played back repeatedly.

RPT 2: All-tracks repeat of one disc
All tracks on the current or specified CD will be played back repeatedly.

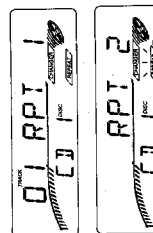

SPECIFICATIONS

AUDIO AMPLIFIER SECTION

Maximum Power Output: (Front) 40 watts per channel (Rear) 40 watts per channel
 Continuous Power Output (RMS): (Front) 16 watts per channel into 4 Ω, 40 to 20,000 Hz at no more than 0.8% total harmonic distortion. (Rear) 16 watts per channel into 4 Ω, 40 to 20,000 Hz at no more than 0.8% total harmonic distortion.

Load Impedance: 4 Ω (4 to 8 Ω allowance)

Tone Control Flange

Bass: ±10 dB at 100 Hz

Treble: ±10 dB at 10 kHz

Frequency Response: 40 to 20,000 Hz

Signal-to-Noise Ratio: 70 dB

Line-Out Level/Impedance: 4.0 V/20 kΩ load (CD changer mode)

RADIO SECTION

Frequency Range

FM: 87.5 to 107.9 MHz

(with channel interval set to 200 kHz)

87.5 to 108.0 MHz

(with channel interval set to 50 kHz)

AM: 530 to 1,710 kHz

(with channel interval set to 10 kHz)

531 to 1,602 kHz

(with channel interval set to 9 kHz)

[FM Tuner]

Usable Sensitivity: 11.3 dBf (1.0 μV/75 Ω)

50 dB Quieting Sensitivity: 16.3 dBf

(1.8 μV/75 Ω)

Alternate Channel Selectivity:

(400 kHz): 65 dB

Frequency Response: 40 to 15,000 Hz

Stereo Separation: 35 dB

Capture Ratio: 1.5 dB

[AM Tuner]

Sensitivity: 20 μV

Selectivity: 35 dB

ENGLISH

CASSETTE DECK SECTION

Wow & Flutter: 0.11% (WRMS)

Fast-Wind Time: 100 sec. (C-60)

Frequency Response (NR-OFF):

30 to 18,000 Hz (±3dB) (Metal/CR02 tape)

30 to 16,000Hz (±3dB) (Normal tape)

Signal-to-Noise Ratio: (Normal tape)

(Dolby NR-ON): 60 dB

(Dolby NR-OFF): 54 dB

Stereo Separation: 40 dB

GENERAL

Power Requirement

Operating Voltage: DC 14.4 volts

(11 to 16 volts allowance)

Grounding System: Negative ground

Dimensions (W x H x D) Installation Size: 182 x

52 x 150 mm (7-3/16" x 2-1/16" x 5-15/16")

Panel Size: 188 x 58 x 14 mm (7-7/16" x

2-5/16" x 5/8")

Gross Weight: 2.2 kg (4.9 lbs)

Design and specifications subject to change without notice.

If a kit is necessary for your car, consult your telephone directory for the nearest car audio speciality shop.

Muchas gracias por haber comprado este producto de JVC. Tenga a bien leer detenidamente este manual de instrucciones antes de la operación de la unidad, para asegurarse de que la entiende perfectamente y para obtener una larga vida de servicio de la misma.

INDICE

OPERACION DE LA RADIO 30

Escucha de la radio

Almacenado automático en memoria de las radiodifusoras

Memoria secuencial de la estación más fuerte (SSM) 31

Almacenamiento de las radiodifusoras deseadas en memoria

Presintonización manual de radiodifusoras 32

Recepción de estaciones presintonizadas

Sintonización de estación presintonizada 33

En caso de que una radiodifusión FM estereofónica tenga interferencia

Botón monofónico 34

Empiezo de esta unidad en un área que no sea Norteamérica o América del Sur

Cambio de intervalos entre canales 34

OPERACION DE LA CINTA 35

Escucha de una cinta

Para emplear tanto como sea posible

Limpeza de la cabeza 38

Consejos para el cuidado de cintas 38

MANDO A DISTANCIA 38

AJUSTE DEL RELOJ 39

OTRAS FUNCIONES 40

Selección de la fuente deseada con la alimentación desconectada

Operación de un sólo toque 40

Ajuste de las características de sonido

Control del nivel de audio 40

Selección de características de sonido adecuadas al género musical

Memoria de control de sonido (ajustada en fábrica) 41

Cambio del ajuste de sonido como sea necesario

Memoria de control de sonido (ajuste del usuario) 42

Ajuste cada modo para que se adecue a sus necesidades

Control del modo de ajuste preferido (PSM) 43

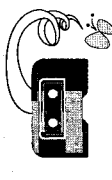

OPERACION DE LA RADIO

Escucha de la radio

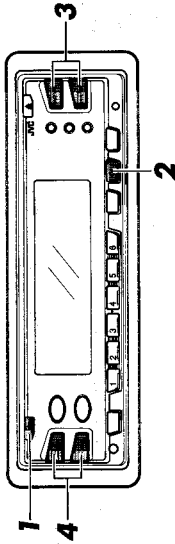

1 ATT Encender.

2 FM 1 → FM 2 → FM 3 → AM Seleccione la banda.
 FM1, FM2, y FM3 tienen los mismos límites de frecuencia es posible presintonizar hasta 6 radiodifusoras en cada banda.

3 Presione para buscar hacia arriba.
 Sintonizar.
 Presione para buscar hacia abajo.
 Emplee la sintonización o la búsqueda manual. (Ver página 33.)

4 Nivel de volumen
 Ajustar volumen.
 Indicador de nivel de ajuste de volumen (Ver página 43.)

Note:
 Botón Power (P)/Atenuador (ATT) : Cuando se presiona este botón durante la operación, el volumen se reduce y el indicador ATT parpadea.
 Power (P) : Presiónelo durante más de 1 segundo para apagar OFF la alimentación.
 Presiónelo nuevamente para regresar al volumen original.

ESPAÑOL

Control automático de volumen de acuerdo a la velocidad del automóvil 44
 Modo cruceo de audio 44
 Uso de voz o de pitidos para confirmar las operaciones 47
 Sistema de apoyo de voz 47
 Cuando sale del automóvil 48
 Método para extraer el panel de control 48
 Método para colocar el panel de control 48

Empleo de otro equipo

OPERACION DEL CAMBIADOR

DE CD 49
 Reproducción de todas las pistas
 Reproducción de discos compactos 49
Selección de un disco
 Selección de disco 50
Salto al principio de una pista
 Reproducción con salto 50
Ubicación de la posición deseada en el disco
 Reproducción con búsqueda 51
Reproducción aleatoria de pistas
 Reproducción aleatoria 51
Reproducción repetida de una pista
 Repetición de la reproducción 51



LOCALIZACION DE AVERIAS 52



ESPECIFICACIONES 53

ANTES DE USAR

*** Para seguridad....**
 No levante demasiado el volumen ya que ello bloqueará los sonidos exteriores haciendo la conducción peligrosa. Pare el automóvil antes de efectuar las operaciones complicadas.

*** Temperatura dentro del automóvil....**
 Si el automóvil ha estado estacionado durante largo tiempo en un lugar caliente o frío, espere hasta que la temperatura dentro del mismo se normalice, antes de operar la unidad.





Almacenado automático en memoria de las radiodifusoras

Memoria secuencial de la estación más fuerte (SSM)

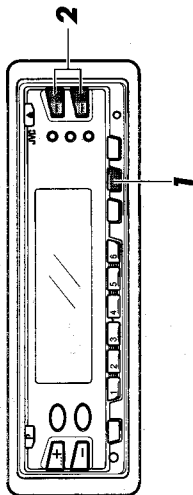
Esta función busca las estaciones de FM que emiten las señales más fuertes. Las 6 estaciones más fuertes son almacenadas en la memoria en orden creciente de frecuencia, y pueden ser rellamadas con los botones No. 1 a No. 6 de estaciones presintonizadas.

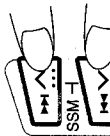

1  **FM 1**
 Seleccione la banda.
 (FM1, FM2 o FM3)

2  **-- 55M --**
 Presione conjuntamente los botones SSM (, ) durante más de 3 segundos.

- Las señales más intensas en la banda que está escuchando (FM1, FM2 o FM3), serán automáticamente exploradas y seleccionadas. Hay seis estaciones presintonizadas en los botones de estación presintonizada (No. 1 a No. 6), en orden de frecuencia creciente. (Durante esta operación, "SSM" se enciende en el visor). La unidad sintoniza automáticamente la emisora almacenada en el botón "1" de estación presintonizada.

ESPAÑOL



Almacenamiento de las radiodifusoras deseadas en memoria Presintonización manual de radiodifusora

Usted puede presintonizar un máximo de 6 estaciones en cada banda (FM1, FM2, FM3 y AM) de la siguiente manera.

- Ejemplo (para almacenar la emisora de FM de 88.3 MHz de la banda FM1 en el botón de almacenamiento de emisoras "1")

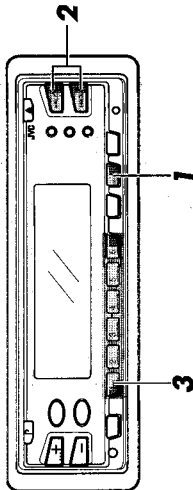

1  **FM 1**
 Seleccione la banda FM1 utilizando el botón de banda (BAND).

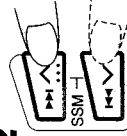
2  **88.3**
 Emplee de la sintonización manual o búsqueda de sintoniza para encontrar la radiodifusora que desea almacenar en memoria. (Ver página 33.)
 Indicador de nivel de sensibilidad del sintonizador (Ver página 43.)

3  **Ich 88.3**
 Presione el botón "1" de estación presintonizada durante más de 2 segundos. (Cuando "MEMO" parpadea en la indicación de estación presintonizada, la estación está presintonizada.)
 ● Repita el procedimiento de arriba para los otros 5 botones de estación presintonizada y para otras bandas (FM2, FM3 y AM).

- Notas:**
- Cuando se almacena una nueva estación en la memoria, se borra la estación presintonizada anteriormente.
 - Las estaciones presintonizadas se borran cuando se corta la alimentación del circuito de la memoria durante el reemplazo de la batería, etc. Cuando ello ocurra, presintonice las estaciones nuevamente.

Recepción de estaciones presintonizadas

Sintonización de estación presintonizada

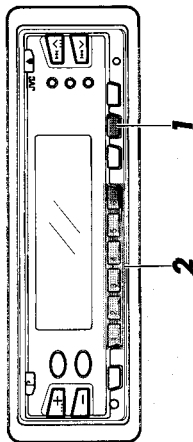

Seleccione la banda.

Presione los botones requeridos de estación presintonizada (No. 1 a No. 6).

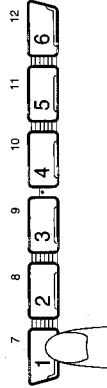

Sintonización manual

Para activar el modo manual, mantenga presionado el botón de sintonización (o el botón de sintonización para sintonizar la frecuencia deseada).

Los pasos de búsqueda de frecuencia son los siguientes:
 FM — en unidades de 200 kHz (o 50 kHz)
 AM — en unidades de 10 kHz (o 9 kHz)

• Aproximadamente 5 segundos después de completar la sintonización manual la unidad conmuta otra vez al modo de búsqueda y se apaga el indicador "MANU".

Sintonización por búsqueda

Presione el botón o el ; la unidad ingresa en el modo de búsqueda de sintonía y sintoniza frecuencias más altas o más bajas. Cuando se recibe una emisión, la sintonización para automáticamente y se puede escuchar el programa.

Búsqueda de sintonía

Cuando presiona el botón de búsqueda, se inicia la búsqueda automática hacia las frecuencias más altas. Cada vez que la unidad recibe una radiodifusión, la frecuencia indicada parpadea y es monitoreada durante 5 segundos aprox. Si usted desea escuchar la frecuencia sintonizada, presione otra vez el botón de búsqueda para desactivar la búsqueda automática.



En caso de que una radiodifusión FM estereofónica tenga interferencia

Botón monofónico

Cuando una emisión de FM sea demasiado ruidosa como para ser escuchada satisfactoriamente, active MONO.

Ruido de antena

Si se escucha ruido de estática cuando escucha AM o FM, verifique que las conexiones de la antena no estén flojas.

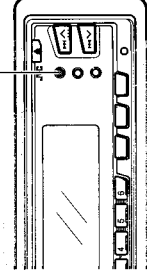

Empleo de esta unidad en un área que no sea Norteamérica o América del Sur

Cambio de intervalos entre canales

Cuando esta unidad se adquiere, esta unidad está ajustada a intervalos de canal de 10 kHz para AM y de 200 kHz para FM. Si se la usa en un área que no sea América del Norte o del Sur ajústela de la siguiente manera:

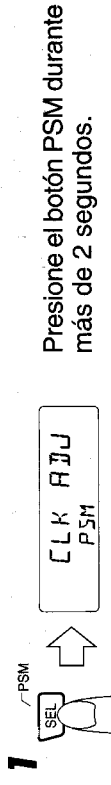
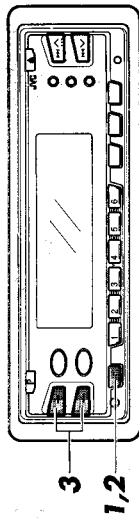

Presione el botón PSM durante más de 2 segundos.

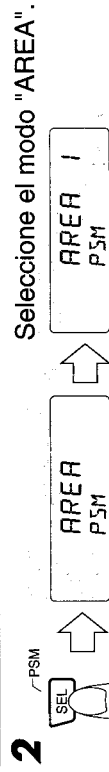

Seleccione el modo "AREA".

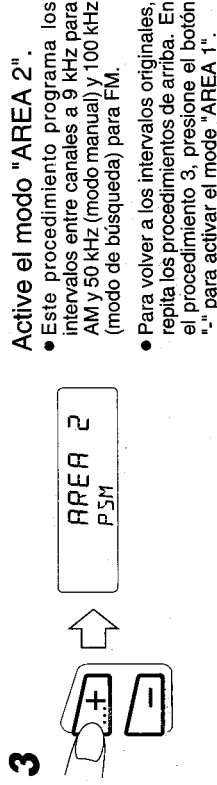

Active el modo "AREA 2".

• Este procedimiento programa los intervalos entre canales a 9 kHz para AM y 50 kHz (modo manual) y 100 kHz (modo de búsqueda) para FM.

• Para volver a los intervalos originales, repita los procedimientos de arriba. En el procedimiento 3, presione el botón "1" para activar el modo "AREA 1".

OPERACION DE LA CINTA

Escucha de una cinta

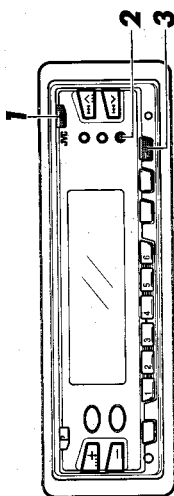

ESPAÑOL

1 Coloque un cassette.

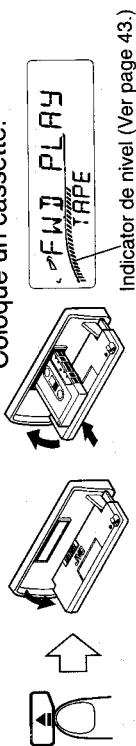

2 Presione el botón (D) Dolby B NR como sea necesario.

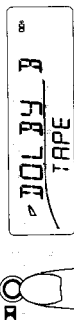

3 Seleccione un programa (sentido de cinta).

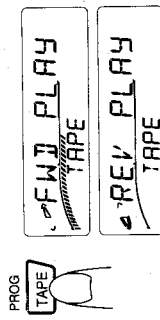

Notas:

- No toque la cabeza reproductora altamente pulida con ninguna herramienta metálica o magnética.
- Nunca reproduzca cintas sucias o polvorientas ya que esto degradará grandemente el sonido y el rendimiento de su unidad. Siempre mantenga limpias sus cintas.
- Los cassettes pueden ser insertados/ejectados aún cuando la alimentación esté desconectada (OFF).
- Botón DOLBY B NR
Presione el botón (D) Dolby B NR como sea necesario.
ON - se enciende el indicador (DDB)
OFF - se apaga el indicador (DDB)
- Reductor de ruido Dolby fabricado bajo licencia de Dolby Laboratories Licensing Corporation. DOLBY y el símbolo de la D doble DD son marcas de Dolby Laboratories Licensing Corporation.



Colocación de la cinta

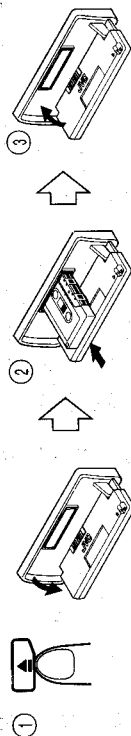

- 1 Abra el panel de control presionando el botón (A).
 - 2 Inserte la cinta con la etiqueta hacia arriba dentro de la ranura para colocación. (La cinta insertado parcialmente entrará automáticamente y se iniciará la reproducción).
 - 3 Cierre el panel de control con la mano.
- * Los botones no funcionan durante 2 segundos después de cerrar el panel de control.

Extracción de discos

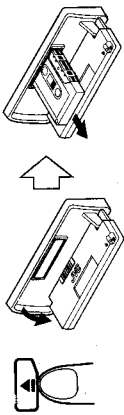

Para extraer la cinta presione el botón (A); se abre el panel de control y la cinta saltará hacia afuera permitiendo la extracción del mismo.

Nota:
• La colocación/extracción de la cinta es posible aun después que se apague OFF la llave de encendido del vehículo.

* Modo de prohibición de eyección de cinta

Aun cuando se presione el botón (A) mientras la unidad está en este modo, es imposible extraer la cinta.
Para activar este modo, presione el botón TAPE conjuntamente con el botón (P) durante 2 segundos o más. Cuando esta función está activada "EJECT" parpadea. Para desactivar esta función, repita el procedimiento de arriba. "EJECT" se enciende indicando que puede extraer la cinta.

Mecanismo dedesconexión/reproducción al retirar la llave del encendido

Cuando se coloca la llave de encendido en OFF, el mecanismo de desconexión por extracción de la llave, desengancha automáticamente la cabeza magnética, e ingresa en el modo de espera. Cuando se coloca la llave del encendido en ON, se activa automáticamente el modo de reproducción.

Mecanismo de inversión automática

Cuando la cinta llega al fin, este mecanismo conmuta automáticamente a la reproducción del otro lado. Para escuchar el otro lado de la cinta durante la reproducción, presione el botón PROG. El cambio de dirección puede ser verificado en el indicador de la dirección de la cinta.

Mecanismo de selección automática de cinta

Esta unidad posee un mecanismo de selección automática de cinta que distingue los diferentes tipos de cinta. Cuando la unidad detecta el fin de la cinta, ésta será actualizada automáticamente en el nivel más adecuado.

Bobinado y rebobinado rápido de las cintas

Presione el botón >>> durante más de 1 segundo para avanzar rápidamente el lado que está siendo reproducido; cuando la unidad detecta el fin de la cinta, ésta será reproducida inversamente desde el comienzo del otro lado.
Presione el botón <<< durante más de 1 segundo para rebobinar la cinta hasta su comienzo, desde el cual recomenzará la reproducción.



Presione el botón PROG durante el avance o rebobinado rápido, para reiniciar la reproducción desde la posición actual.



Llamada del sintonizador

Si presiona el botón \llcorner ó \triangleright durante más de 1 segundo, durante la operación de la cinta, la unidad ingresa automáticamente en el modo de radio y se escucha la estación en la cual está sintonizada. Cuando se cancela el avance rápido o el rebobinado, la reproducción de la cinta continúa. (Si en número de búsqueda preajustada de música está parpadeando esta operación no se ejecutará). Esta operación puede ser cancelada (reiterarse al "Control del modo de ajuste preferido (PSM)" en la página 43).

Operación de exploración de múltiples músicas

Esta función le permite la reproducción automática desde el principio de una canción particular (saltando un máximo de 9 músicas), hacia adelante o hacia atrás. Durante la reproducción, presione el botón \triangleright o \llcorner una vez para cada música que desee saltar.

• Ejemplo (cuando salta hacia adelante a la 3ra. música)



• Presione tres veces.

• Cuando la unidad detecta el principio de la música especificada, el número indicador se apaga y se inicia la reproducción de la cinta.

• Durante la exploración, y cuando la cinta es rebobinada hasta su principio en el modo de rebobinado, la reproducción

comienza desde el principio de ese lado. Cuando la cinta llega al fin en el modo de avance rápido, la reproducción es invertida comenzando desde el principio del otro lado.

Salto de espacios no grabados

Con este botón en ON y durante la reproducción, las secciones no grabadas de más de 15 segundos, entre las canciones, son saltadas y la cinta es avanza rápidamente hacia la próxima canción. Esta operación también funciona con inversión automática, saltando desde el fin de la última canción de un lado a la primera canción del otro lado de cinta.



Función de repetición

Para escuchar repetidamente la canción que está siendo reproducida, presione el botón RPT. Cuando la canción termina, la cinta es automáticamente rebobinada hasta el principio de la misma y se reinicia la reproducción. Para cancelar este modo, presione el botón otro vez.

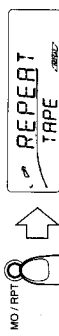

Nota:

En los siguientes casos, la exploración de múltiples músicas, el salto de espacios no grabados y la función de repetición puede que no funcionen correctamente. Estas NO son fallas; utilice los mecanismos para adecuarse a los materiales y a las situaciones.

- Cintas con canciones que tienen largos pasajes pianissimo (partes muy suaves), o porciones no grabadas.
- Cintas con canciones que fueron grabadas con bajos niveles de grabación.
- Cintas con secciones cortas no grabadas.
- Cintas con altos niveles de ruido o zumbido entre canciones.
- Ajustes del botón de reducción de ruido (Dolby B NR), que no coinciden el modo NR de la cinta.

ESPAÑOL



Para emplear tanto como sea posible

Limpeza de la cabeza

• Cinta para limpieza de cabezas

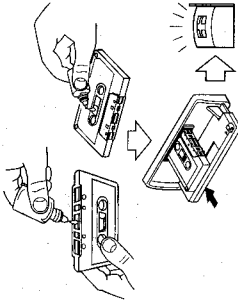

Las cabezas son importantes ya que captan el sonido. Cuando se ensucian aparecen los siguientes síntomas:

- Se reduce la calidad del sonido.
- Se reduce el nivel del sonido.
- El sonido se escucha intermitentemente (ocurre una caída del mismo).

Estas NO son fallas. Sin embargo, antes de que aparezcan estos síntomas, limpie las cabezas cada 10 horas utilizando una cinta para limpieza de cabezas de tipo húmedo, disponibles en las tiendas de audio. Por más detalles refiérase a las instrucciones sobre la cinta para limpieza de cabezas.

Consejos para el cuidado de cintas

Es muy importante conservar sus cintas limpias. Colóquelas siempre en sus respectivas cajas después de reproducirlas.

Nunca las coloque bajo la luz solar directa, en lugares muy húmedos o extremadamente calientes.

Nunca reproduzca cintas sucias, con polvo o con etiquetas que se están desadhiriendo, ya que pueden dañar el aparato.

La cinta floja dentro del cassette puede causar problemas enredándose en el eje de arrastre o en el rodillo de presión.

- Cuando no escuche las cintas, extraiga sin falta el cassette de la ranura de colocación, ya que la cinta puede aflojarse.

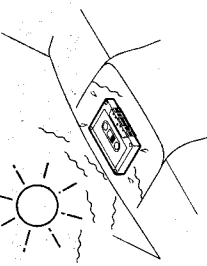

Incorrecto

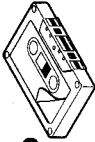

Nota:

Su unidad necesita muy poca atención, pero su funcionamiento óptimo sólo puede ser asegurado si sigue las notas de arriba.



MANDO A DISTANCIA

Las siguientes operaciones pueden ser ejecutadas utilizando el mando a distancia. Verifique detalladamente las funciones de los botones de operación y opérelas correctamente.

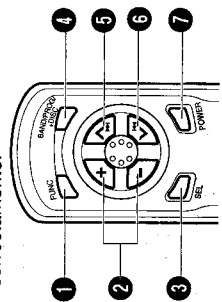

- 1 Botón de función (FUNC) Usado para seleccionar la fuente.
- 2 Botones de control de nivel
- 3 Botón (SEL) selector del modo de control electrónico
- 4 Botón BAND/PROG+DISC (Banda/Programa/Disco)
- 5 Botón de sintonización SEEK/bobinado rápido/salto (búsqueda) SEEK hacia arriba (\curvearrowright)/avance rápido (\blacktriangleright)



OTRAS FUNCIONES

Selección de la fuente deseada con la alimentación desconectada

Operación de un sólo toque

El presionar el botón mostrado abajo conecta la alimentación y selecciona la fuente aun cuando la alimentación esté desconectada.

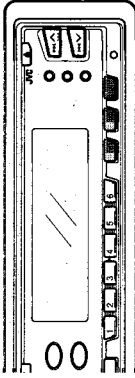

	Modo defunción	Operaciones
	CD	Coloque un CD en el cambiador de CD conectado a esta unidad y presione este botón para iniciar la reproducción del CD.
	TUNER	Al presionar cualquier botón se activa el sintonizador.
	TAPE	La reproducción de la cinta comienza cuando se presiona este botón habiendo una cinta colocada.

• El presionar el botón DISP. conecta la alimentación y después de indicar la hora durante 5 segundos, la desconecta.

Ajuste de las características de sonido

Control del nivel de audio

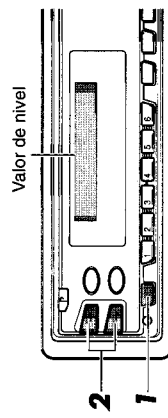

1. Seleccione el modo de control con el botón SEL.
2. Ajuste el nivel con los botones de control de nivel.

Modo de control electrónico	1	2	Ajustar.
VOL	Selección.	Disminuye (00 - 50)	Aumenta
BAS	Volumen	Disminuye (-06) - (+06)	Aumenta
TRE	Graves	Disminuye (-06) - (+06)	Aumenta
FAD	Agudos	Posterior (R06 - F06)	Frontal
BAL	Desvanecedor	Izquierdo (L06 - R06)	Derecho
LOU	Equilibrio	Desactivada	Activada
	Loudness		

ESPAÑOL



- Botón de sintonización SEEK/bobinado rápido/salto (búsqueda) SEEK hacia abajo (↙)/rebobinado (↖)
- Botón de alimentación (POWER)

Reemplazo de las pilas

Cuando el funcionamiento del mando a distancia es inestable o la radio de acción del mismo se acorta, reemplace las pilas por nuevas.

- Instalación de las pilas en el mando a distancia.

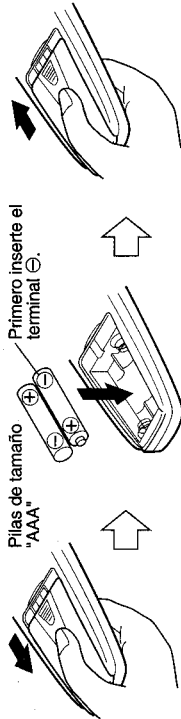

Uso del mando a distancia

Para usar el mando a distancia, apúntela al sensor remoto y presione los botones gentili y firmemente. No exponga el sensor remoto a luz fuerte (luz directa del sol o luz artificial), asegurándose de que no hay obstáculos entre el sensor remoto y el mando a distancia.

Sensor remoto

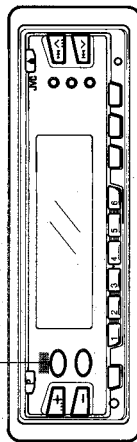

AJUSTE DEL RELOJ

Selección de la indicación de reloj

Cada vez que presiona el botón DISP. la indicación conmuta entre el modo de escucha y el de reloj.

Método para ajustar el reloj

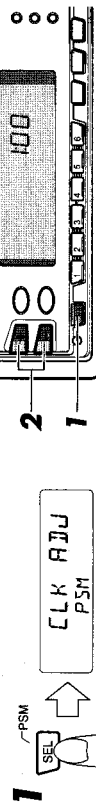

Presione el botón PSM durante más de 2 segundos para seleccionar el modo "CLK ADJ".

- Minutos
- Horas

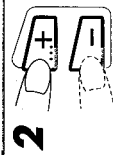

2 Ajustar.

- Después de ajustar presione el botón DISP.



Control de atenuación

- Cuando se lo utiliza en un sistema de 4 altavoces
Utilice este control para equilibrar los niveles de volumen de los altavoces delanteros y traseros.
- Cuando se lo utiliza en un sistema de 2 altavoces
Coloque este control en la posición central (indicación "00").

Control de sonoridad

Con volúmenes bajos el oído humano es menos sensible a las frecuencias bajas y altas. Cuando el volumen es bajo, coloque el control de sonoridad en ON para incrementar estas frecuencias y producir un sonido bien equilibrado.

ESPAÑOL

Selección de características de sonido adecuadas al género musical

Memoria de control de sonido (ajustada en fábrica)

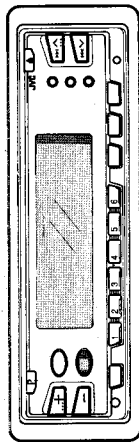

Modo de sonido	Valor preajustado de nivel		Sonoridad
	Graves	Agudos	
SCM OFF Desactivada	00	00	Activada
BEAT Ritmo	+02	00	Activada
SOFT Suave	+01	-03	Desactivada
POP Pop	+04	+01	Desactivada



Cambio del ajuste de sonido como sea necesario

Memoria de control de sonido (ajuste del usuario)

Los valores de preajuste del modo de sonido pueden ser cambiados de acuerdo a su gusto. (Ejemplo: Para enfatizar los sonidos graves con los modos de compás desde el nivel 2 al 5)

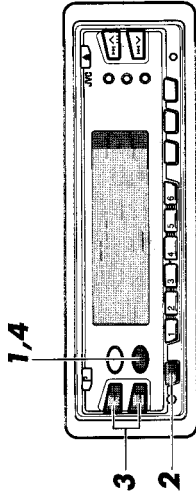

1 Presione el botón SOUND para seleccionar el modo al que desea cambiar (ritmo, suave, pop).

2 Presione el botón SEL dentro de 5 segundos para seleccionar la características de sonido que desea cambiar (grave, agudo, sonoridad).

3 Ajuste el nivel deseado dentro de 5 segundos con el botón de control de nivel.

4 Para almacenar el nivel establecido en memoria presione el botón SOUND dentro de los 5 segundos y manténgalo presionado durante más de 2 segundos (El modo de "MEMO" indicación parpadea cuando el nivel ha sido almacenado en memoria).

* Repita el procedimiento de arriba para cambiar otros valores preajustados.
* Para restituir el valor preajustado repita el procedimiento de arriba utilizando como referencia el valor de nivel de la memoria de control de sonido (ajustada en fábrica).



Ajuste cada modo para que se adecue a sus necesidades

Control del modo de ajuste preferido (PSM)

El PSM ha sido ajustado en fábrica, pero puede ser modificado de acuerdo a sus necesidades.

1. Para ajustar PSM, presione el botón PSM durante más de 2 segundos.
Para seleccionar cada modo presione el botón PSM.
2. Ajuste el modo deseado con los botones (+, -) de control de nivel.

ESPAÑOL

1 Selección. PSM	2 Ajustar.		Ajustes en fábrica
CLK ADJ Ajuste del reloj	Hora	Minuto	1:00
LEVEL Nivel	AUDIO ↔ ANTENNA ↔ OFF		AUDIO
VOICE Voz	VOICE 1 ↔ VOICE 2 ↔ OFF BEEP 2 ↔ BEEP 1 ↔		VOICE 1
DIMMER Atenuador	Desactivado	Automático	Automático
AREA Area	AREA 1	AREA 2	AREA 1
TU CALL Llamada del sintonizador	Desactivada	Activada	Activada

- LEVEL: Las funciones son las siguientes
AUDIO - Indicador de nivel de audio
ANTENNA - Indica el nivel de sensibilidad del sintonizador en el modo sintonizador.
OFF - Indicador de nivel ajuste de volumen
- DIMMER: El ajuste del atenuador puede ser colocado en AUTO/OFF.
AUTO - Cuando enciende los faros del automóvil durante la noche la luz de indicación del tablero de control se reduce automáticamente.
OFF - Brillo normal.



Control automático de volumen de acuerdo a la velocidad del automóvil

Modo crucero de audio

Esta función detecta la frecuencia de generación del alternado y la emplea para ajustar automáticamente el volumen al nivel más confortable (hay 3 niveles posibles) de acuerdo con la velocidad del automóvil.

Ajuste del modo crucero

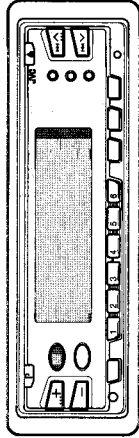

Presione el botón CRUISE para seleccionar el modo crucero.



Cuando selecciona CRUISE 1 o CRUISE 2 la indicación parpadea.



Audio Cruise funciona.

- Hay muchos tipos de ruidos mientras se conduce. Sin embargo si usted está conduciendo un automóvil que produce ruidos relativamente altos, emplee CRUISE 2. (El volumen de CRUISE 2 es el doble en relación al volumen de CRUISE 1).
- Cuando el AUDIO CRUISE MODE está activado, el nivel de volumen es automáticamente seleccionado entre 1, 2 y 3 de acuerdo con la velocidad de giro del motor.

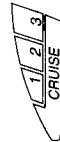

Ejemplo: Indica el nivel 3.



**Si el modo cruceo de audio no funciona correctamente
Método para ajustar la velocidad de ralenti en memoria**

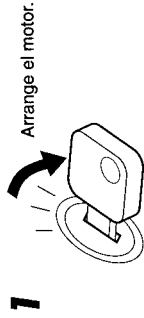
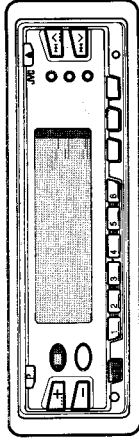

Caliente el motor.

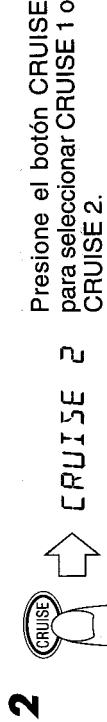

Manteniendo el botón CRUISE presionado, presione el botón SEL durante más de 2 segundos para almacenar la velocidad de ralenti en memoria.

Nota:
Hay cierto número de factores tales como el arranque del motor eléctrico, limpieparabrisas, ventanillas motorizadas, antenas motorizadas, acondicionadores de aire, etc. que pueden hacer que el modo cruceo no funcione correctamente. En este caso, desconecte de la batería o de cualquier otra conexión, el conductor (amarrillo) de apoyo de memoria.

Después de efectuar los pasos de arriba, el nuevo ajuste CRUISE es automáticamente comprobado. Si no funciona correctamente, el modo CRUISE se desactiva automáticamente y queda cancelado el ajuste de velocidad de ralenti. En este caso, refiérase a la nota siguiente.



Cuando el volumen es excesivo o insuficiente seleccione los ajustes de modo para su automóvil.

Ejemplo: Cuando el aumento es insuficiente.

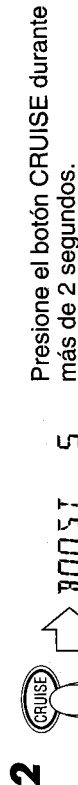
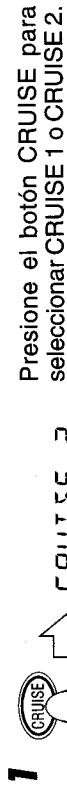
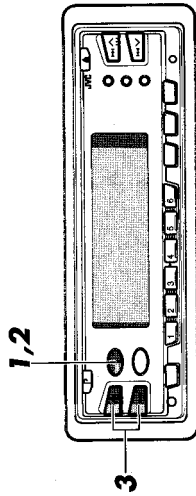

Presajuste el nivel de refuerzo máximo.

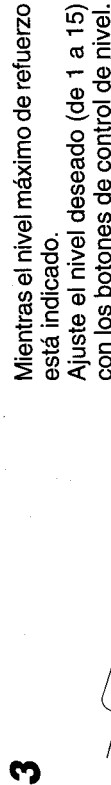

El nivel de refuerzo máximo es reposicionado y la unidad activa el modo que estaba previamente activado.

•Después de cambiar el ajuste, pruebe el modo cruceo de audio.



Uso de voz o de pitidos para confirmar las operaciones

Sistema de apoyo de voz

Dependiendo del ajuste este sistema responde a la voz (INGLÉS) o a pitidos. (Por ejemplo, cuando se conecta la alimentación, la unidad dice "HELLO"). Ajuste cada modo para que se adecue a sus necesidades.

Método para seleccionar el mod

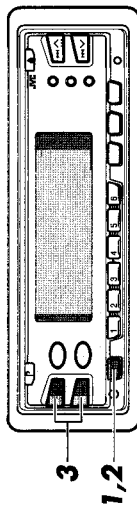

1



Para activar PSM, presione el botón PSM durante más de 2 segundos.

2

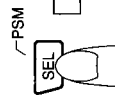

Seleccione el mode "VOICE".

3

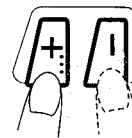

Seleccione.

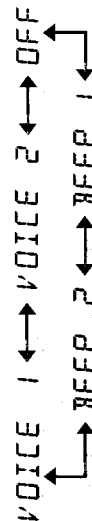

VOICE 1: El nivel de voz es bajo.
 VOICE 2: El nivel de voz es alto.
 BEEP 1: El nivel del pitido es bajo.
 BEEP 2: El nivel del pitido es alto.
 OFF: Sin sonid.

• Después del ajuste de modo usted puede comprobar el sistema de apoyo de voz presionando cada botón de operación.

Notas:

- El sistema de apoyo de voz sólo saca sonido por los altavoces frontales. Si se emplean sólo los altavoces traseros, no se escuchará ningún sonido.
- Cuando use esta unidad con un amplificador externo conectado, disminuya el control de ganancia del amplificador ya que la voz o el pitido del sistema de apoyo de voz o el pitido del sistema de apoyo de voz serán más altos que lo usual (sin emplear el amplificador).



Cuando sale del automóvil

Método para extraer el panel de control

Antes de extraer el panel de control, asegúrese de desconectar la alimentación.

1

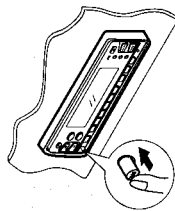

Presione el botón de liberación (⊕) del panel de control para extraerlo.

2

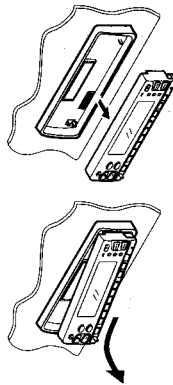

Tire el panel de control de la unidad principal como se muestra.

3

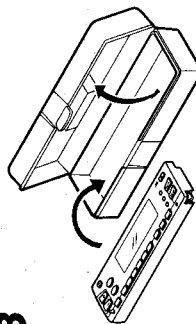

Coloque el panel de control en la caja suministrada para protección.

Método para colocar el panel de control

1

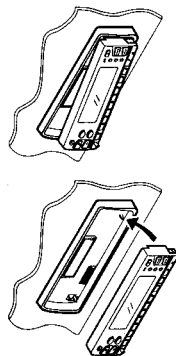

Inserte el lado derecho del panel de control dentro de la ranura del lado derecho del soporte.

2

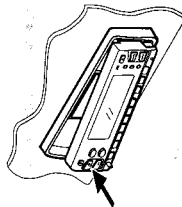

Presione el lado izquierdo para colocarlo correctamente.

Limpieza del conector

Si extrae frecuentemente el panel de control, puede producirse una falsa conexión con el soporte del mismo. Para reducir esta posibilidad al mínimo, límpielo periódicamente con un hisopo, o paño humedecido en alcohol, tomando precauciones para no dañar los terminales del conector.

Nota:

- Tome precauciones para no dañar los terminales conectores cuando coloca/extrae el panel de control o mientras el mismo está extraído.

Empleo de otro equipo

OPERACION DEL CAMBIADOR DE CD

PRECAUCIONES

- Esta unidad sirve para controlar el cambiador automático de CD de JVC (a ser adquirido separadamente).
- Para la correcta utilización, refiérase a las instrucciones del cambiador automático de CD.
- Cuando no haya discos en el magazín del cambiador de CD o los discos estén

colocados al revés, "NO DISC" aparecerá en el indicador. Si esto ocurre, extraiga el magazín y coloque los discos correctamente.

- Cuando aparece "RESET 1 - RESET 8" en el display de la unidad, verifique que el cordón esté conectado y presione el botón RESET del cambiador de CD.

ESPAÑOL

Reproducción de todas las pistas

Reproducción de discos compactos

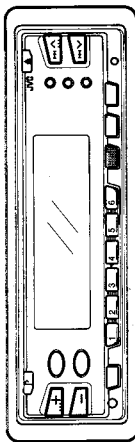

Número de pista

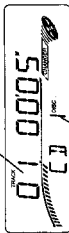
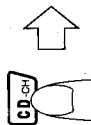

Número de disco

Seleccione la función de cambiador de CD.

- Cuando todas las músicas del primer disco han sido reproducidas, se inicia automáticamente la reproducción del segundo disco desde la primera música.



Selección de un disco

Selección de disco

Ejemplo: (para especificar el disco 5)

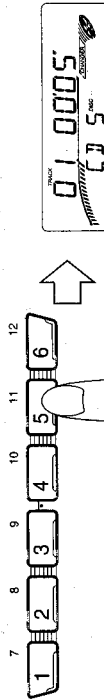

• Selección directa de disco

Presione el botón de número de disco que corresponde al disco deseado (presione rápido para seleccionar del No. 1 al No. 6 o durante más de 1 segundo para seleccionar del No. 7 al No. 12). Se encenderá el número de disco y el de pista y se iniciará la reproducción del CD.

• Botón de selección de disco (utilizando el mando a distancia)

Presione el botón de selección de disco (+ DISC) para seleccionar el disco deseado.

Ejemplo: cuando se está reproduciendo el tercer disco... Cada vez que se presiona el botón +DISC serán seleccionados en secuencia el 4º, 5º, 6º, y 1º disco.



Salto al principio de una pista

Reproducción con salto

- Durante la reproducción usted puede saltar fácilmente al comienzo de la pista anterior, actual o de la próxima y la reproducción recomenzará desde ese punto.

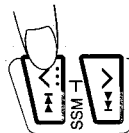

Para escuchar la próxima pista...

Presione una vez el botón (▶▶) para saltar al comienzo de la próxima pista.

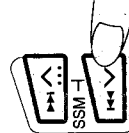

Para escuchar la pista anterior...

Presione una vez el botón (◀◀) para saltar al comienzo de la pista actual, y luego otra vez para saltar a la pista anterior.

- * Cuando se ejecutan las operaciones de selección de disco y salto en secuencia, es posible seleccionar la pista deseada del disco indicado.

LOCALIZACIÓN DE AVERIAS

Lo que parece ser un problema puede no ser grave. Primero asegúrese

Simptomas	Causas	Remedios
* No es posible colocar el cassette.	El cassette está incorrectamente colocado.	Inserte el cassette con la cinta expuesta apuntando hacia arriba.
* El cassette de cinta se calienta.	Esto no es una falla.	—
* El sonido es muy bajo y la calidad del mismo está degradada.	La cabeza de cinta está sucia.	Limpíela regularmente con un de cabezas.
El sonido se interrumpe algunas veces.	El cordón está incorrectamente conectado.	Confirme las conexiones del cordón.
* El sonido no sale por los altavoces.	El control de volumen está en el nivel mínimo.	Ajustelo al nivel óptimo.
* La sintonización automática no funciona.	El cordón está incorrectamente conectado.	Confirme las conexiones del cordón.
* "NO DISC" está indicado.	La señal de radiodifusión es débil.	Sintonice las radiodifusoras manualmente.
* "RESET 8" está indicado.	Los CD no están colocados en el magazin. Los CD están incorrectamente insertados.	Inserte los CD en el magazin. Asegúrese de que estén correctamente insertados.
* "RESET 7" está indicado.	Esta unidad no está conectada correctamente a un cambiador de CD.	Conecte esta unidad correctamente y presione el botón de reposición del cambiador de CD.
* La unidad no funciona aunque se presione cualquier botón.	El microcomputador incorporado no funciona correctamente debido a interferencia, etc.	Presione conjuntamente el botón P (Power) y el botón SEL durante más de 2 segundos para reposicionar la unidad. (El ajuste del reloj y de las radioemisoras presintonizadas en memoria queda cancelado y la unidad vuelve a los ajustes originales.)

ESPAÑOL



Ubicación de la posición deseada en el disco

Reproducción con búsqueda

- La posición deseada puede ser localizada utilizando la búsqueda rápida hacia adelante o hacia atrás durante la reproducción.
- Mantenga presionado el botón para iniciar la búsqueda. (La velocidad de la misma aumenta cuanto más tiempo se mantenga presionado el botón.)
- Se escuchará un sonido de bajo volumen (aprox. un cuarto del de reproducción), monitoree el sonido y libere el botón cuando localice la posición deseada.

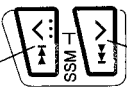

Mantenga presionada para la búsqueda rápida regresiva.

Reproducción aleatoria de pistas

Reproducción aleatoria

Cada vez que presione el botón RND, el modo cambia de aleatorio 1 (se enciende el indicador RND), a aleatorio 2 (el indicador RND parpadea), a borrado.



Aleatorio 1:
Reproduce una vez aleatoriamente todas las pistas del disco actual, luego las de los discos siguientes en orden.

Aleatorio 2:
Selecciona aleatoriamente y reproduce las pistas de todos los CD colocados en el magazin.

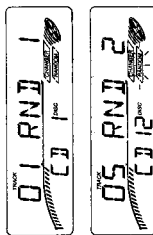

Reproducción repetida de una pista

Repetición de la reproducción

Cada vez que se presiona el botón RPT, el modo cambiará de RPT 1 (se enciende el indicador RPT), a RPT 2 (parpadea el indicador RPT), al modo de borrado, en este orden.

RPT 1: Repetición de una sola pista.
La pista especificada será reproducida repetidamente.

RPT 2: Repetición de todas las pistas de un disco.
Todas las pistas del disco presente o del especificado serán reproducidas repetidamente.

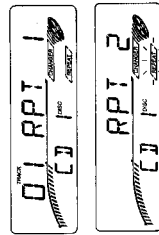

ESPECIFICACIONES

SECCION DEL AMPLIFICADOR DE AUDIO
 Máxima potencia de salida: (Frontal) 40 W por canal (Trasera) 40 W por canal
 Potencia de salida continua (RMS): (Frontal) 16 W por canal dentro de 4 Ω, 40 a 20.000 Hz con distorsión armónica no mayor de 0,8%.
 (Trasero) 16 W por canal dentro de 4 Ω, 40 a 20.000 Hz con distorsión armónica no mayor de 0,8%.

Impedancia de carga: 4 Ω (tolerancia de 4 a 8 Ω)
 Límites de control de tono
 Graves: ±10 dB a 100 Hz
 Agudos: ±10 dB a 10 kHz
 Respuesta de frecuencia: 40 a 20.000 Hz
 Relación señal - ruido: 70 dB
 Nivel de salida de línea/impedancia: carga de 4,0 V/20 kΩ (modo de cambiador de CD)

SECCION DE RADIO

Límites de frecuencia
 FM: 87,5 a 107,9 MHz
 (con intervalos entre canales de 200 kHz)
 87,5 a 108,0 MHz
 (con intervalos entre canales de 50 kHz)
 AM: 530 a 1.710 kHz
 (con intervalos entre canales de 10 kHz)
 531 a 1.602 kHz
 (con intervalos entre canales de 9 kHz)
 [Sintonizador de FM]
 Sensibilidad utilizable: 11,3 dBf (1,0 μV/75 Ω)
 Umbral de sensibilidad de 50 dB: 16,3 dBf (1,8 μV/75 Ω)

Selectividad de canal alternado: (400 kHz): 65 dB
 Respuesta de frecuencia: 40 a 15.000 Hz
 Separación estereofónica: 35 dB
 Relación de captación: 1,5 dB
 [Sintonizador de AM]
 Sensibilidad: 20 μV
 Selectividad: 35 dB

SECCION DE LA PLATINA DE CASSETTE
 Fluctuación y trémolo: 0,11% (WRMS)
 Tiempo de bobinado rápido: 100 seg. (C-60)
 Respuesta de frecuencia (NR-OFF):
 30 a 18.000 Hz (±3 dB) (Cinta de metal/CrO₂)
 30 a 16.000 Hz (±3dB) (Cinta normal)
 Relación señal-ruido (Cinta normal)
 (Dolby NR-ON): 60dB
 (Dolby NR-OFF): 54dB
 Separación estereofónica: 40 dB

GENERALIDADES

Requisitos de potencia
 Voltaje de funcionamiento: 14,4 voltios CC (margen de 11 a 16 voltios)
 Sistema de puesta a tierra: Masa negativa
 Dimensiones (A x Alt. x P):
 Tamaño de instalación: 182 x 52 x 150 mm
 Tamaño del panel: 188 x 58 x 14 mm.
 Peso bruto: 2,2 kg

El diseño y las especificaciones están sujetos a cambio sin aviso.

Si fuera necesario un juego de instalación para su automóvil, consulte la guía telefónica para ubicar la tienda espe-cialista en audio para automóviles más cercana.

Nous vous remercions pour l'achat d'un appareil JVC. Veuillez lire avec soin toutes les instructions avant de faire fonctionner l'appareil, pour être sûr d'avoir bien tout compris et pour obtenir une durée d'utilisation plus longue de l'appareil.

SOMMAIRE

FONCTIONNEMENT DE LA RADIO 56
 Ecoute de la radio 56
 Mise en mémoire automatique de stations
 Mémoire séquentielle de station puissante (SSM) 57
 Mise en mémoire des stations désirées 58
 Préréglage manuel de station 58
Réception des stations pré-réglées 59
 Synchronisation des pré-réglages 59
Lorsqu'une émission stéréo FM est bruitée 60
 Touche mono 60
Utilisation de cet appareil dans une région autre que l'Amérique du Nord ou du Sud 60
 Pour changer l'intervalle entre les canaux 60

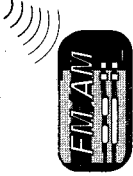

FONCTIONNEMENT DE LA BANDE 61
 Ecoute d'une bande 61
Pour l'usage aussi long que possible 64
 Nettoyage de la tête 64
 Conseils pour l'entretien des bandes 64

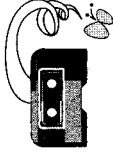

TELECOMMANDE 64



REGLAGE DE L'HORLOGE 65



AUTRES FONCTIONS 66
Sélection de la source désirée avec l'alimentation coupée 66
 Fonctionnement une touche 66
Ajustement des caractéristiques sonores 66
 Commande de niveau audio 66
Sélection des caractéristiques sonores convenant au genre de musique 67
 Mémoire de commande de son (préréglage usine) 67
Changement de réglage de son comme requis 68
 Mémoire de commande de son (préréglage de l'utilisateur) .. 68
Réglage de chaque mode pour répondre à vos besoins 69
 Commande de mode de réglage préféré (PSM) 69
Contrôle du volume automatiquement en fonction de la vitesse de déplacement de la voiture 70
 Mode de croisière audio 70
Utilisation de voix ou de tonalités sonores pour confirmer des opérations 73
 Système support de voix 73



ESPAÑOL

FONCTIONNEMENT DE LA RADIO

Ecoute de la radio

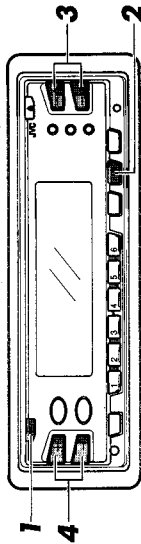

Mettre en marche.



FM 1 → FM 2 → FM 3 → AM Sélectionner la gamme.

FM1, FM2 et FM3 ont la même bande de fréquence et jusqu'à 6 stations peuvent être pré-réglées dans chaque gamme.

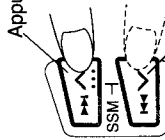

Sintoniser.

Utiliser la syntonisation manuelle ou par recherche pour trouver une station. (Voir page 59.)

Appuyer pour la recherche ascendante.

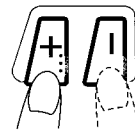

Niveau de volume



Régler le volume.

Indicateur de niveau de sensibilité du syntonisateur (Voir page 69.)

Remarque:
 Interrupteur d'alimentation (P) /
 Atténuateur (ATT)
 Power (P): Appuyer pour mettre l'alimentation sur marche.
 Appuyer pendant plus d'une seconde pour couper l'alimentation.

Lorsque cette touche est pressée pendant le fonctionnement, le volume descend et l'indicateur ATT clignote. Appuyer à nouveau pour revenir au volume original.

En laissant la voiture
 Pour détacher le panneau de commande 74
 Pour fixer le panneau de commande 74

Utilisation de l'autre matériel

FONCTIONNEMENT DU CHANGEUR CD 75

- Lire toutes les pistes
 Lecture de disques audionumériques 75
- Sélectionner un disque
 Sélection de disque 76
- Sauter au début d'une piste
 Saut de lecture 76
- Localiser une position requise sur le disque
 Recherche en lecture 77
- Lire les pistes dans un ordre aléatoire
 Lecture aléatoire 77
- Lire la piste de façon répétée
 Lecture répétée 77



EN CAS DE DIFFICULTES 78



CARACTERISTIQUES TECHNIQUES .. 79

AVANT UTILISATION

- * **Pour la sécurité**
 Ne pas relever le niveau de volume trop fort, ce qui pourrait empêcher d'entendre les sons extérieurs, rendant la conduite dangereuse.
 Arrêtez la voiture avant d'effectuer des opérations compliquées.
- * **Température à l'intérieur de la voiture....**
 Si la voiture a stationné longtemps par temps chaud ou froid, veuillez attendre que la température dans la voiture devienne normale avant de faire fonctionner l'appareil.



Mise en mémoire automatique de stations

Mémoire séquentielle de station puissante (SSM)

Cette fonction recherche en FM des stations diffusant des signaux puissants. Les 6 stations les plus puissantes sont maintenues en mémoire dans l'ordre des fréquences ascendantes, et peuvent être rappelées avec les touches de stations pré-réglées (No. 1 à No. 6).

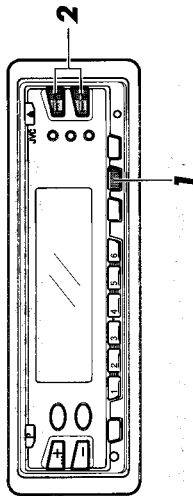

1



FM 1

Sélectionner la gamme.
(FM1, FM2 ou FM3)

2

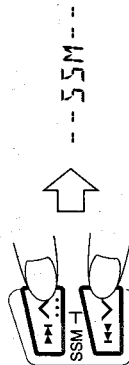

Appuyer sur les deux touches SSM (↔, ↕) pendant plus de 3 secondes.

- Les signaux les plus puissants dans la gamme que vous écoutez (FM1, FM2 ou FM3) seront recherchés et sélectionnés automatiquement. Six stations sont pré-réglées dans les touches de stations pré-réglées (No. 1 à No. 6), dans l'ordre des fréquences ascendantes. (Pendant cette opération, "SSM" est allumé dans l'affichage.) L'appareil se syntonise alors automatiquement sur l'émission rangée dans la touche de stations pré-réglées "1".

FRANÇAIS



Mise en mémoire des stations désirées

Préréglage manuel de station

Vous pouvez pré-régler jusqu'à 6 stations dans chaque (FM1, FM2, FM3 et AM) gamme comme suit.

- Exemple (pour pré-régler la touche de stations pré-réglées "1" de la gamme FM1 sur une station FM à 88,3 MHz)

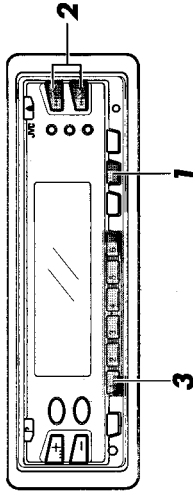

1



FM 1

Sélectionner la gamme FM1 en utilisant la touche de gamme (BAND).

2

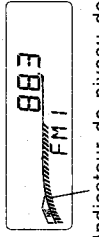
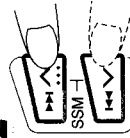

Indicateur de niveau de sensibilité du syntonisateur (Voir page 69.)

Utiliser la syntonisation manuelle, ou par recherche pour trouver une station que vous voulez mettre en mémoire. (Voir page 59.)

3

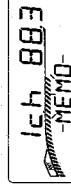

Appuyer sur la touche de stations pré-réglées "1" pendant plus de 2 secondes. (Quand "MEMO" clignote dans l'affichage de stations pré-réglées, la station est pré-réglée.)

- Refaire la procédure ci-dessus pour les 5 autres touches de stations pré-réglées et pour les autres gammes (FM2, FM3 et AM).

Remarques:

- Une station pré-réglée précédente est effacée quand une nouvelle station est mise en mémoire.
- Les stations pré-réglées sont effacées quand l'alimentation du circuit de mémoire est interrompue pendant le remplacement de la batterie, etc. Dans ce cas, pré-régler à nouveau les stations.

Réception des stations préréglées

Syntonisation des préréglages

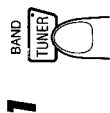
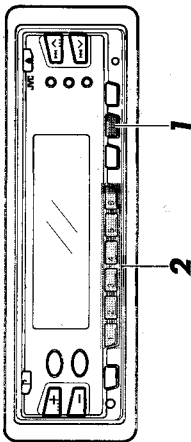

FM 1 → FM 2 → FM 3 → AM

Sélectionner la gamme.

2

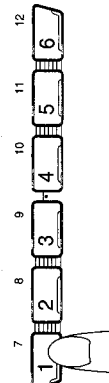

Appuyer sur les touches de stations préréglées requises (No.1 à No.6).

Syntonisation manuelle

Pour passer en mode manuel, presser et maintenir la touche de syntonisation (↖ ou ↗). L'indicateur "MANU" clignote. Appuyer sur la touche de syntonisation pour syntoniser à la fréquence désirée.

Les pas de balayage des fréquences sont comme suit:

FM — par pas de 200 kHz/50 kHz

AM — par pas de 10 kHz/9 kHz

- Environ 5 secondes après la fin de la syntonisation manuelle, l'appareil revient en mode de recherche et l'indicateur "MANU" s'éteint.

Syntonisation par recherche

Appuyer sur la touche ↖ ou ↗; l'appareil passe en mode de recherche et s'accorde sur une fréquence plus élevée ou plus basse. Quand une émission est reçue, il arrête automatiquement la recherche et l'émission peut être entendue.

Syntonisation par balayage

Lorsque la touche SCAN est pressée, le balayage automatique commence vers des fréquences plus élevées. Chaque fois qu'une émission est reçue, la fréquence affichée clignote et elle est contrôlée pendant 5 secondes environ. Si vous voulez écouter l'émission accordée, appuyer de nouveau sur la touche Scan pour arrêter le balayage automatique.

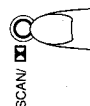

Lorsqu'une émission stéréo FM est bruitée

Touche MONO

Régler sur MONO quand une émission FM stéréo contient trop de bruit et ne peut être bien écoutée.

Parasites d'antenne

Si vous entendez des bruits statiques quand vous écoutez une émission AM ou FM, vérifiez si les raccordements de l'antenne ne sont pas défectueux.

Utilisation de cet appareil dans une région autre que l'Amérique du Nord ou du Sud

Pour changer l'intervalle entre les canaux

A la livraison de cet appareil, l'intervalle entre les canaux est réglé sur 10 kHz pour AM et 200 kHz pour FM. Si l'appareil est utilisé dans une autre région que l'Amérique du Nord ou du Sud, régler comme suit:

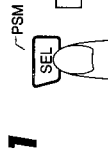
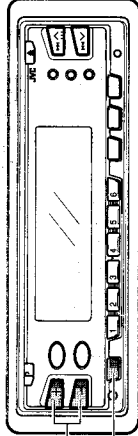

1

CLK A J J
P.S.M

Appuyer sur la touche de PSM pendant plus de 2 secondes.



2

AREA P.S.M

Sélectionner en mode "AREA".



3

AREA 2
P.S.M

Passer en mode "AREA 2".

- Effectuer cette procédure règle l'intervalle entre les canaux sur 9 kHz en AM et sur 50 kHz (mode manuel), 100 kHz (mode de recherche) en FM.

- Pour revenir aux intervalles d'origine, répéter les procédures ci-dessus. Dans la procédure 3, appuyer sur la touche "1" pour régler sur le mode "AREA 1".

FONCTIONNEMENT DE LA BANDE

Ecoute d'une bande

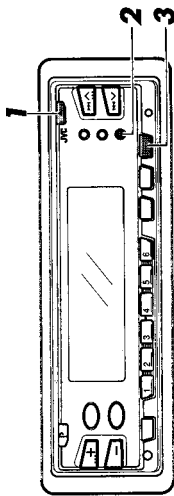

1 Introduire une cassette.

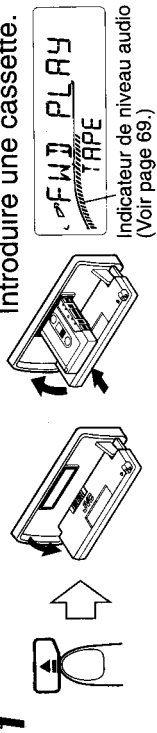

2 Régler la touche de réduction de bruit DOLBY B NR (DB) comme requis.



3 Sélectionner un programme (sens de défilement de la bande).

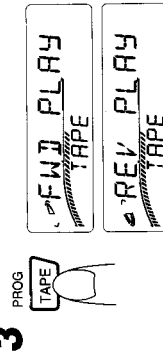

Notes:

- Ne pas toucher à la tête de lecture polie avec un objet métallique ou magnétique.
- Ne jamais utiliser des bandes sales ou poussiéreuses car le son et les performances de votre appareil en seraient grandement dégradés, il faut donc toujours conserver vos bandes propres.
- Des cassettes peuvent être introduites/éjectées même quand l'alimentation est coupée.

Mise en place d'une bande

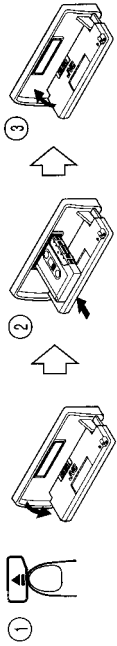

- 1 Ouvrir de panneau de commande en appuyant sur la touche (▲).
 - 2 Introduire une bande (l'étiquette en haut) dans la fenêtre de chargement. (Lorsque la bande est introduite en partie, il est rentré automatiquement et la lecture commence.)
 - 3 Fermer le panneau de commande à la main.
- * Les touches ne fonctionnent pas pendant 2 secondes après fermeture du panneau de commande.

Retrait de disques

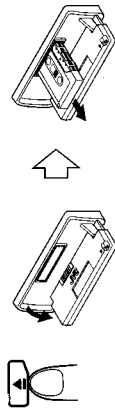

Pour retirer une bande, appuyer sur la touche (▲); le disque sort pour permettre son retrait.

Remarque:

- Le chargement/retrait de bande est possible même avec le contact du véhicule coupé.

* Mode d'interdiction d'éjection de bande

Même si la touche (▲) est pressée alors que l'appareil est dans ce mode, il est impossible de sortir une bande.
Pour engager ce mode, tout en appuyant sur la touche (P) pendant 2 secondes ou plus, "EJECT" clignote quand cette fonction est effective. Pour relâcher cette fonction, répéter la procédure précédente. "EJECT" clignote, montrant que la bande peut être sortie.

Mécanisme de relâchement par coupure du contact (Lecture par mise du contact)

Lorsque le contact est coupé, le mécanisme de "relâchement par coupure du contact" libère la bande de la tête magnétique, puis passe en mode d'attente. Lors de la mise du contact, le mode de lecture reprend automatiquement.

Dispositif de sélection automatique de bande

Cet appareil dispose d'un dispositif de sélection automatique de bande qui fait une distinction entre différents types de bandes. Lorsque le type est détecté, la correction est réglée à son niveau le mieux adapté.

Avance rapide et réembobinage des bandes

Appuyer sur la touche ► pendant plus d'une seconde pour faire défiler en avant la face étant lue; lorsque la fin de la bande est détectée, la bande est inversée et la lecture commence à partir du début de l'autre face. Appuyer sur la touche ◀ pendant plus d'une seconde pour réembobiner la bande à son début, où la lecture reprend. Appuyer sur la touche PROG pour lancer la lecture à partir de la position courante pendant l'avance rapide ou le réembobinage.

Mécanisme d'inversion automatique

Lorsque la bande arrive à sa fin, ce mécanisme commut automatiquement la lecture sur l'autre face. Pour écouter l'autre face de la bande pendant la lecture, appuyer sur la touche PROG. Le changement de sens de défilement peut être vérifié avec l'indicateur de sens de défilement de la bande.



Pour l'usage aussi long que possible

Nettoyage de la tête

Les têtes sont importantes, elles captent le son. Quand elles deviennent sales, les symptômes suivants deviennent perceptibles:

- La qualité du son est réduite.
- Le niveau sonore diminue.
- Le son peut être entendu de façon intermittente.

(Des coupures de son se produisent.)
Ce ne sont PAS des mauvais fonctionnements. Toutefois, avant que ces symptômes apparaissent, nettoyez les têtes toutes les 10 heures d'utilisation en utilisant une cassette de nettoyage de têtes de type humide, disponible dans un magasin de produits audio. Pour plus de détails, se reporter aux instructions de la cassette de nettoyage de têtes.

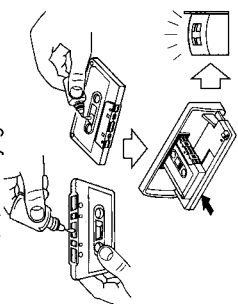

Conseils pour l'entretien des bandes

Il est très important de conserver vos bandes propres. Toujours les remettre dans leurs boîtes après la lecture. Ne jamais ranger vos bandes en plein soleil, dans un endroit très humide ou extrêmement chaud.

Ne jamais lire des bandes sales ou poussiéreuses ou des bandes avec les étiquettes se détachant - elles pourraient endommager l'appareil.

- Une bande détendue dans une cassette peut causer des problèmes en se prenant dans le mécanisme.
- **Toujours retirer les cassettes de la fente de chargement en dehors de l'écoute, car la bande risque de se détendre.**

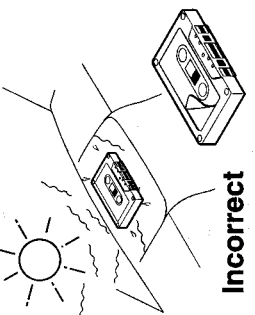

Incorrect

Remarque:

Votre appareil a besoin de très peu de soin, mais vous serez assuré des meilleures performances que si vous suivez les remarques ci-dessus.



TELECOMMANDE

Les opérations suivantes peuvent être effectuées en utilisant la télécommande.

- Vérifier avec soin les fonctions des touches de fonctionnements et les utiliser correctement.
- 1 Touche de fonction (FUNC)
Utilisée pour sélectionner la source.
 - 2 Touches de commande de niveau
 - 3 Touche de sélection de mode de commande électronique (SEL)
 - 4 Touche BAND/PROG/+DISC
 - 5 Touche de syntonisation par recherche (SEEK)/défilement rapide/saut
 - 6 Recherche ascendante SEEK (↗)/avance rapide (▶▶)
 - 7 Touche de syntonisation par recherche (SEEK)/défilement rapide/saut
 - 8 Recherche descendante SEEK (↘)/rembobinage (◀◀)
 - 9 Touche d'alimentation (POWER)

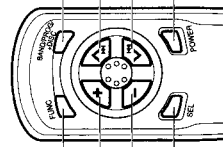

à partir du début de cette face. Si la bande arrive à sa fin en mode d'avance rapide, elle est inversée et lue à partir du début de l'autre face.

Saut de blanc

Pendant la lecture avec cette touche ON, des sections vierges de plus de 15 secondes entre des morceaux sont sautées et la bande défile rapidement en avant jusqu'au morceau suivant. Cette opération fonctionne également avec l'inversion automatique, sautant de la fin du dernier morceau sur une face au premier morceau sur l'autre face de la bande.



Fonction de répétition

Appuyer sur la touche RPT pendant que le morceau que vous voulez entendre plusieurs fois est lu. Lorsque la fin du morceau est atteinte, la bande revient automatiquement au début du morceau et la lecture reprend. Appuyer à nouveau sur la touche pour annuler ce mode.



Remarque:

Dans les cas suivants, la recherche musicale multiple, le saut de blanc et la fonction de répétition peuvent ne pas fonctionner correctement. Ce ne sont PAS des mauvais fonctionnements; utiliser les dispositifs avec du matériel et des situations appropriés.

- Des bandes avec des morceaux contenant de longs plantis (parties très douces) ou des portions non enregistrées dans les morceaux musicaux.
- Des bandes avec des morceaux enregistrés à faibles niveaux d'enregistrement.
- Des bandes avec des sections non enregistrées trop courtes.
- Des bandes avec du bruit ou ronflement de niveau élevé entre les morceaux.
- Les réglages de la touche de réduction de bruit Dolby B NR ne correspondent pas au mode de réduction de bruit de la bande.

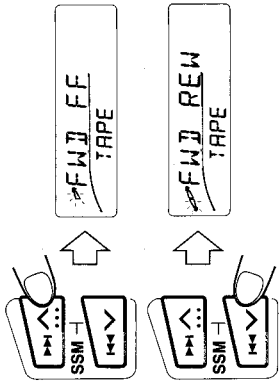

Appel de la radio

Pendant le fonctionnement cassette, si la touche ◀◀ ou ▶▶ est pressée pendant plus d'une seconde, l'appareil passe automatiquement en mode radio et la station sur laquelle l'appareil est syntonisé sera entendue. Lorsque le mode d'avance rapide ou de rembobinage est annulé, la lecture de la cassette revient. (Si le numéro de pré-réglage de recherche musicale clignote, cette opération ne sera pas effectuée.) Esta operación puede ser cancelada (refiérase al "Control del modo de ajuste preferido (PSM)" en la página69).

Fonctionnement de la recherche musicale multiple

Cette fonction vous permet de lire automatiquement à partir du début d'un morceau spécifié (en sautant jusqu'à un maximum de 9 morceaux), en avant ou en arrière.

Pendant la lecture, appuyer une fois sur la touche ▶▶ ou ◀◀ pour chaque morceau que vous voulez sauter.

- Exemple (Pour sauter en avant au 3ème morceau)
- Appuyer trois fois.

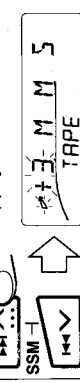

- Lorsque le début du morceau spécifié est détecté, le numéro d'indication s'éteint et la lecture de la bande commence.
- Pendant la recherche, si la bande est rembobinée jusqu'à son début en mode de rébobinage, la lecture commence



AUTRES FONCTIONS

Sélection de la source désirée avec l'alimentation coupée

Fonctionnement une touche

Même si l'alimentation est coupée, une pression sur la touche montrée ci-dessous met l'alimentation en marche et sélectionne la source.

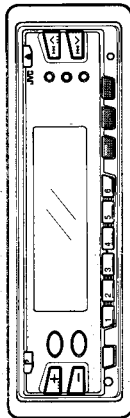

Mode fonction	Opérations
	Placer un disque dans le changeur CD raccordé à cet appareil et appuyer sur cette touche pour lancer la lecture CD.
	Lorsque cette touche est pressée, le sintoniseur est engagé.
	Quand cette touche est pressée avec une cassette en place, la lecture de la bande commence.

- Une pression sur la touche DISP met en marche l'alimentation et après affichage du mode d'horloge pendant 5 secondes, la coupe.

Ajustement des caractéristiques sonores

Commande de niveau audio

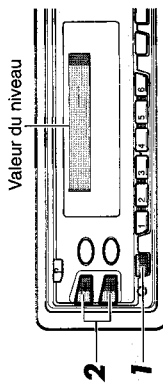

1. Sélectionner le mode de commande avec la touche SEL.
2. Ajuster le niveau avec les touches de commande de niveau.

Mode de commande électronique	1	2	Régler.
	Volume	Diminue (00 - 50)	Relève
	Graves	Diminue (-06) - (+06)	Relève
	Aigus	Diminue (-06) - (+06)	Relève
	Équilibrage	Arrière (R06 - F06)	Avant
	Balance	Gauche (L06 - R06)	Droite
	Contour	Arrêt	Marche

FRANÇAIS



- **Changement des piles**
Lorsque le fonctionnement de la télécommande devient instable ou si la distance à partir de laquelle la télécommande est possible devient plus courte, remplacer les piles par des neuves.

- Mise en place des piles dans la télécommande.

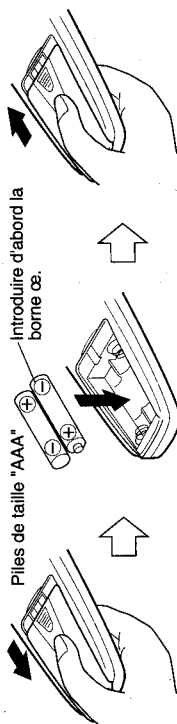

Utilisation de la télécommande

Pour utiliser la télécommande, la pointer vers détecteur de télécommande et appuyer gentiment et fermement sur les touches. Ne pas exposer le détecteur de télécommande à un éclairage puissant (lumière directe du soleil ou éclairage artificiel) et s'assurer qu'il n'y a pas d'obstacles entre le détecteur de télécommande et la télécommande.

Détecteur de télécommande

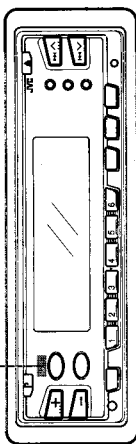

REGLAGE DE L'HORLOGE

Sélectionner l'affichage de l'horloge

Chaque fois que la touche DISP est pressée, l'affichage est commuté entre le mode d'écoute et le mode d'horloge.

Réglage de l'horloge

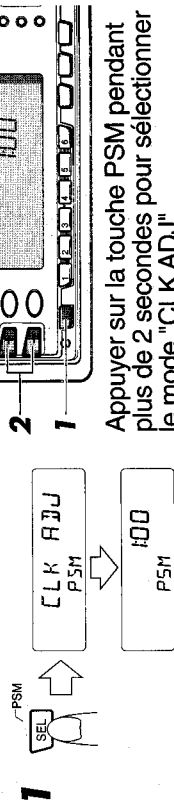

Régler.

- Minutes
 - Heures
- Après réglage, appuyer sur la touche DISP.



Commande d'équilibrage

- Pour un système à 4 haut-parleurs
Utiliser cette commande pour équilibrer les niveaux de volume des haut-parleurs avant et arrière.
- Pour un système à 2 haut-parleurs
Régler cette commande sur la position centrale ("00" est affiché).

Commande de contour

A bas volume, l'oreille humaine est moins sensible aux hautes et basses fréquences. Lorsque le volume est faible, régler la commande de contour sur ON pour relever ces fréquences et produire un son bien équilibré.

Sélection des caractéristiques sonores convenant au genre de musique

Mémoire de commande de son (préréglage usine)

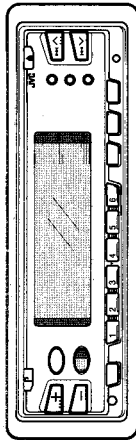

Mode de son	Valeur de niveau préréglée	
	Graves	Aigus
SCM OFF Arrêt	00	Contour
BEAT Rythme	+02	Marche
SOFT Léger	+01	Arrêt
POP Pop	+04	Arrêt



Changement de réglage de son comme requis

Mémoire de commande de son (préréglage de l'utilisateur)

Les valeurs préréglées du mode de son peuvent être changées pour correspondre à vos goûts. (Exemple: Pour relever le son grave avec le niveau de mode rythme de 2 à 5)

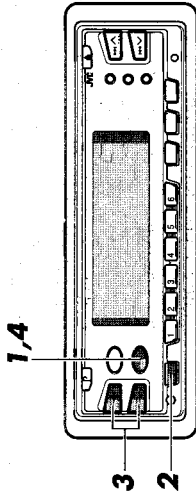

1 Appuyer sur la touche SOUND pour sélectionner le mode à changer (Rythme, Léger, Pop).

2 Appuyer sur la touche SEL dans les 5 secondes pour sélectionner les caractéristiques du son à changer (Graves, Aigus, Contour).

3 Régler le niveau voulu dans les 5 secondes avec la touche de commande de niveau.

4 Pour mettre en mémoire le niveau réglé, appuyer sur la touche SOUND dans les 5 secondes et la maintenir pendant plus de 2 secondes. (L'indication de "MEMO" clignote quand le niveau a été mis en mémoire.)
* Pour changer d'autres valeurs préréglées, répéter la procédure ci-dessus.
* Pour reprendre les valeurs préréglées, répéter la procédure ci-dessus en utilisant la valeur du niveau pour la mémoire de commande de son (préréglage usine) comme référence.



Réglage de chaque mode pour répondre à vos besoins

Commande de mode de réglage préféré (PSM)

Le PSM a été réglé en usine, mais il peut être réglé pour correspondre à vos besoins.

- Appuyer sur la touche PSM pendant plus de 2 secondes pour régler le PSM.
- Appuyer sur la touche PSM pour sélectionner chaque mode.
- Régler le mode voulu avec les touches de commande de niveau (+, -).

1 Sélectionner. PSM	2 Régler.	Préréglages en usine
SEL CLK ADJ Réglage de l'horloge	Heures Minutes	1:00
LEVEL Niveau	AUDIO ↔ ANTENNA ↔ OFF	AUDIO
VOICE Voix	VOICE 1 ↔ VOICE 2 ↔ OFF ↕ BEEP 2 ↔ BEEP 1 ↔	VOICE 1
DIMMER Assombrissement	Arrêt AUTO	AUTO
AREA Zone	ZONE 1 ZONE 2	ZONE 1
TU CALL Appel de la radio	Arrêt Marche	Marche

- LEVEL: Fonctionne comme suit:
AUDIO - L'indicateur de niveau audio.
ANTENNA - Affiche le niveau de sensibilité du sintoniseur en mode sintoniseur.
OFF - L'indicateur de niveau de réglage de volume
- DIMMER: Lorsque le réglage d'assombrissement est sur marche, AUTO/OFF peut être changé.
AUTO - Lorsque les phares de la voiture sont allumés la nuit, l'éclairage de l'affichage du panneau de commande s'assombrira automatiquement.
OFF - Luminosité normale

Contrôle du volume automatiquement en fonction de la vitesse de déplacement de la voiture

Mode de croisière audio

Cette fonction contrôle la fréquence de l'alternateur et l'utilise pour régler automatiquement le niveau du volume au niveau le plus confortable (3 niveaux possibles), en fonction de la vitesse de déplacement de la voiture.

Réglage du mode de croisière

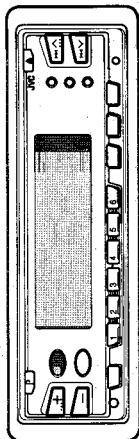

Appuyer sur la touche CRUISE et sélectionner le mode.

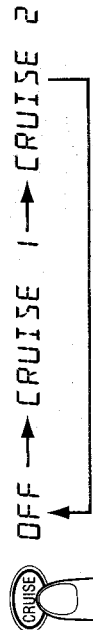

Lorsque CRUISE 1 ou CRUISE 2 est sélectionné, l'affichage clignote.

Audio Cruise fonctionnelle.

- Il y a de nombreuses sortes de bruits en conduisant. Toutefois, si vous conduisez une voiture relativement bruyante, utiliser CRUISE 2. (Le volume du son CRUISE 2 augmente deux fois plus vite que le volume CRUISE 1.)
- Lorsque le réglage AUDIO CRUISE MODE est sur marche, le niveau du volume est sélectionné automatiquement entre 1, 2 ou 3, selon la vitesse de rotation du moteur.

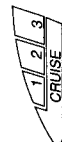

Exemple: Affichages en niveau 3.



Lorsque le mode de croisière audio ne fonctionne pas correctement

Comment régler la vitesse de ralenti en mémoire

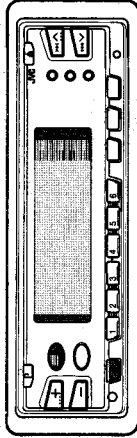

1 Faire démarrer le moteur.

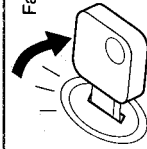

Faire chauffer le moteur.

2 Appuyer sur la touche CRUISE pour sélectionner CRUISE 1 ou CRUISE 2.



3 Le réglage est mis mémoire.

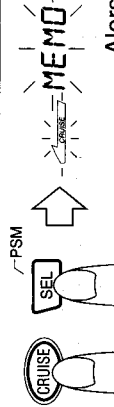

Alors que la touche CRUISE est maintenue pressée, appuyer sur la touche SEL pendant plus de 2 secondes pour mettre en mémoire la vitesse de ralenti.

Remarque:

Un nombre de facteurs, comme la direction assistée, les essuie-glaces, les glaces électriques, les antennes électriques, la climatisation, etc. peuvent empêcher le mode de croisière de fonctionner correctement. Dans ce cas, veuillez brancher le fil de maintien de la mémoire (fil jaune) directement sur la batterie ou à une position proche de la batterie pour éviter l'entrée des parasites dans l'alimentation.

Après avoir suivi les étapes ci-dessus, le nouveau réglage CRUISE est contrôlé automatiquement. S'il ne fonctionne pas correctement, le mode CRUISE est coupé automatiquement et le réglage de la vitesse de ralenti devient invalide. Dans ce cas, veuillez vous référer à la remarque suivante.



Cuando el volumen es excesivo o insuficiente seleccione los ajustes de modo para su automóvil.

Exemple: Lorsque le régime d'augmentation est trop faible.

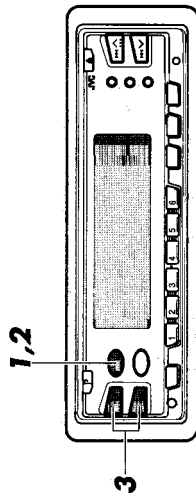

1 Appuyer sur la touche CRUISE pour sélectionner CRUISE 1 ou CRUISE 2.



2 Appuyer sur la touche CRUISE pendant plus de 2 secondes.



Niveau de relèvement maximal pré-réglé

3 Alors que le niveau maximal de relèvement est affiché, régler le niveau que vous voulez (de 1 à 15) avec les touches de commande de niveau.

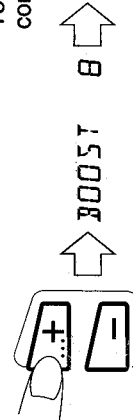

Le niveau de relèvement maximal est réglé de nouveau, et l'appareil passe dans le mode engagé précédemment.

• **Après changement du réglage, veuillez tester le mode de croisière audio.**



Utilisation de voix ou de tonalités sonores pour confirmer des opérations.

Système support de voix

En fonction du réglage, ce système répond avec une voix (en anglais) ou une tonalité sonore. (Par exemple, lorsque l'alimentation est mise en marche, il dit: "HELLO.") Régler chaque mode pour répondre à vos besoins.

Comment sélectionner le mode

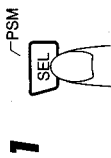
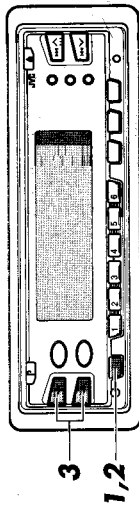

Appuyer sur la touche PSM pendant plus de 2 secondes pour sélectionner le PSM.

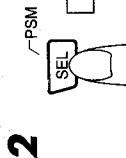

Sélectionner le mode "VOICE".



Sélectionner.

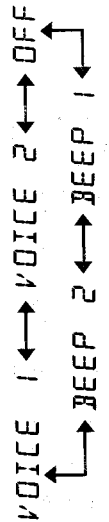

- VOICE 1: Le niveau de voix est faible.
- VOICE 2: Le niveau de voix est élevé.
- BEEP 1: Le niveau sonore de la tonalité est faible.
- BEEP 2: Le niveau sonore de la tonalité est élevé.
- OFF: Pas de son.

Remarques:

- Le système support de voix ne sort le son que sur les haut-parleurs avant. Si uniquement les haut-parleurs arrière sont utilisés, le son ne sera pas entendu.
- En utilisant cet appareil avec un amplificateur externe raccordé, baisser la commande de gain de l'amplificateur car le son de la voix ou de la tonalité du système support de voix peut être plus fort que normal (que si l'amplificateur n'est pas utilisé).

• Après réglage du mode, vous pouvez tester le système support de voix en appuyant sur chaque touche de fonctionnement.



En laissant la voiture

Pour détacher le panneau de commande

Avant de détacher le panneau de commande bien s'assurer de couper l'alimentation.

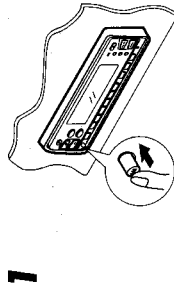

Appuyer sur la touche de libération du panneau de commande (↔) pour détacher le panneau de commande.

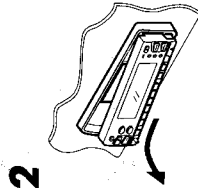

Tirer le panneau de commande de l'appareil, comme montré ci-dessous.

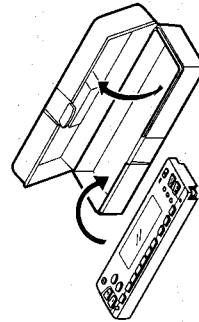

Placer le panneau de commande dans l'étui fourni pour le protéger.

Pour fixer le panneau de commande

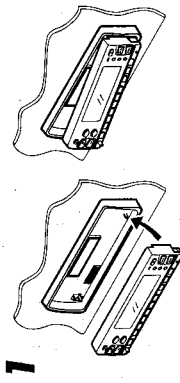

Introduire le côté droit du panneau de commande dans la rainure sur le côté droit du support.

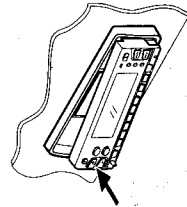

Appuyer sur le côté gauche pour le placer correctement.

Nettoyage du connecteur

Si le panneau de commande est fréquemment détaché, un raccordement médiocre peut se produire avec le support de panneau de commande. Pour réduire ce risque, essayer périodiquement avec un coton-tige ou un tissu imbibé d'alcool, en faisant attention de ne pas endommager les bornes du connecteurs.

Remarque:

- Faire attention de ne pas endommager les bornes du connecteur en fixant/détachant le panneau de commande ou alors que le panneau de commande est retiré.

FONCTIONNEMENT DU CHANGEUR CD

PRECAUTIONS

- Cet appareil est pour la commande d'un changeur automatique de disques audionumériques JVC (à acheter séparément).
- Pour une utilisation correcte, se reporter aux instructions du changeur automatique.
- Quand il n'y a pas de disque dans le

magasin du changeur CD ou si les disques sont introduits sans dessus dessous, "NO DISC" apparaît dans l'affichage. Dans ce cas, retirer le magasin et placer correctement les disques.

- Lorsque "RESET 1-RESET 8" est montré dans l'affichage de l'appareil, vérifier que le cordon est raccorder et appuyer sur la touche RESET du changeur CD.

Lire toutes les pistes

Lecture de disques audionumériques

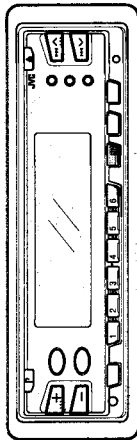

Numéro de piste

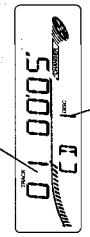

Numéro de disco

Passer en mode changeur CD.

- Lorsque tous les morceaux sur le premier disque ont été lus, le second disque commence automatiquement à partir du premier morceau.



Sélectionner un disque

Sélection de disque

Exemple: (Pour désigner le disque 5)

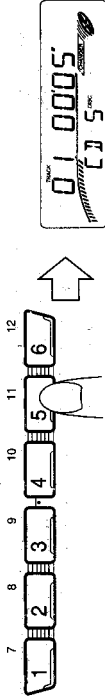

- **Sélection directe de disque**

Appuyer sur la touche de numéro de disque correspondant au disque voulu (la presser rapidement pour sélectionner No.1 à No.6 ou pendant plus d'une seconde pour sélectionner No. 7 à No. 12). Le numéro de disque et le numéro de piste s'allument et la lecture CD commence.

- **Touche de sélection de disque (en utilisant la télécommande)**

Appuyer sur la touche de sélection de disque (+ DISC) pour sélectionner le disque voulu.

Exemple: quand le troisième disque est en cours de lecture ... Chaque fois que la touche +DISC est pressée, le 4ème, 5ème, 6ème ... et le 7ème disque seront sélectionnés en séquence.



Sauter au début d'une piste

Saut de lecture

- Pendant la lecture, vous pouvez facilement sauter au début de la piste précédente, courante ou suivante, et la lecture commencera alors à partir de ce point.

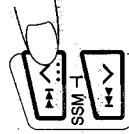

- **Pour écouter le morceau suivant...**

Appuyer une fois sur la touche (▶▶) pour passer au début de la piste suivante.

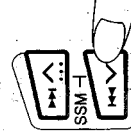

- **Pour écouter le morceau précédent...**

Appuyer une fois sur la touche (◀◀) pour passer au début du morceau courant, puis encore une fois pour passer au morceau précédent.

* La piste voulue d'un disque particulier peut être sélectionnée en effectuant les opérations de sélection de magasin, sélection de disque et saut en séquence.



Localiser une position requise sur le disque

Recherche en lecture

Maintenir pressée pour la recherche accélérée avant.

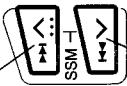

- La position voulue peut être localisée en utilisant la recherche accélérée avant ou arrière pendant la lecture.
- Maintenir pressée la touche pour commencer la recherche. (Plus longtemps la touche est pressée et plus la vitesse de recherche augmente.)
- Comme un faible niveau sonore peut être entendu (environ le quart du niveau de lecture), contrôler le son et relâcher la touche quand la position requise est localisée.

Maintenir pressée pour la recherche accélérée arrière.

FRANÇAIS

Lire les pistes dans un ordre aléatoire

Lecture aléatoire



Chaque fois que la touche RND est pressée, le mode change de Aléatoire 1 ("l'indicateur RND est allumé) à Aléatoire 2 ("l'indicateur RND clignote) à annulation.

Aléatoire 1:

Lit une fois toutes les pistes sur le disque courante de façon aléatoire, puis sur chacun des disques suivants dans l'ordre.

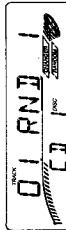

Aléatoire 2:

Sélectionne et lit des pistes de façon aléatoire de tous les disques dans le magasin chargé.

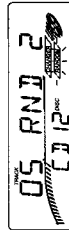

Lire la piste de façon répétée

Lecture répétée



Chaque fois que la touche RPT est pressée, le mode change de RPT 1 ("l'indicateur RPT est allumé) à RPT 2 ("l'indicateur RPT clignote) à annulation, dans cet ordre.

RPT 1: Répétition d'une seule piste
La piste courante ou spécifiée sera lue de façon répétée.

RPT 2: Répétition de toutes les pistes d'un disque
Toutes les pistes sur le disque courant ou spécifiées seront lues de façon répétée.

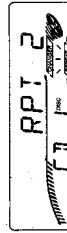
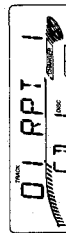

EN CAS DE DIFFICULTES

Ce qui semble être une panne n'est pas toujours sérieux. Vérifier d'abord ...

Symptôme	Causes	Remèdes
* La cassette ne peut pas être chargée.	Elle est chargée de la mauvaise façon.	Introduire la cassette avec la bande exposée sur la droite.
* La cassette devient chaude.	Ce n'est pas un mauvais fonctionnement.	—
* Le son est à un niveau très bas et la qualité du son est dégradée.	La tête de lecture est sale.	La nettoyer régulièrement avec un nettoyeur de tête.
* Le son est quelquefois interrompu.	Le raccordement du cordon est incorrect.	Confirmer les raccordements du cordon.
* Le son ne peut pas être entendu à partir des haut-parleurs.	La commande de volume est tournée sur le niveau minimum.	L'ajuster au niveau optimal.
* La syntonisation automatique ne fonctionne pas.	Le raccordement du cordon est incorrect.	Confirmer les raccordements du cordon.
* "NO DISC" est affiché.	La force du signal d'émission est trop faible.	Syntoniser manuellement les stations.
* "RESET 8" est affiché.	Les CD ne sont pas placés dans le magasin. Les CD sont insérés de façon incorrecte.	Insérer des CD dans le magasin. S'assurer qu'ils sont correctement insérés.
* "RESET 1" est affiché.	Cet appareil n'est pas raccordé correctement au changeur CD.	Lui raccorder correctement cet appareil et appuyer sur la touche de remise à zéro du changeur CD.
* "RESET 7" est affiché.	—	Appuyer sur la touche de remise à zéro du changeur CD.
* L'appareil ne fonctionne pas même si n'importe quelle touche est pressée.	Le microprocesseur incorporé peut ne pas fonctionner correctement à cause de parasites, etc.	Appuyer sur la touche P (Power) et sur la touche SEL pendant plus de 2 secondes en même temps pour remettre à zéro l'appareil. (Le réglage de l'horloge et les stations pré-réglées en mémoire sont annulés et l'appareil revient à son réglage initial.)

KS-RT626

CASSETTE RECEIVER

 Printed in Singapore
 VNN3765-631S

© 1996 VICTOR COMPANY OF JAPAN, LIMITED

79

CARACTERISTIQUES TECHNIQUES

SECTION AMPLIFICATEUR AUDIO

Puissance de sortie maximale: (Avant) 40 W par canal
 (Arrière) 40 W par canal
 Puissance de sortie continue (RMS): (Avant) 16 W par canal sous 4 Ω , 40 à 20.000 Hz avec moins de 0,8% de distorsion harmonique totale.
 (Arrière) 16 W par canal sous 4 Ω , 40 à 20.000 Hz avec moins de 0,8% de distorsion harmonique totale.
 Impédance de charge: 4 Ω (4 à 8 Ω possible)
 Gamme de commande de tonalité
 Graves: ± 10 dB à 100 Hz
 Aigus: ± 10 dB à 10 kHz
 Réponse en fréquence: 40 à 20.000 Hz
 Rapport signal/bruit: 70 dB
 Niveau de sortie ligne/impédance: 4,0 V/20 k Ω (mode changeur CD)

SECTION RADIO

Gamme des fréquences
 FM: 87,5 à 107,9 MHz
 (avec intervalle entre les canaux réglé sur 200 kHz)
 87,5 à 108,0 MHz
 (avec intervalle entre les canaux réglé sur 50 kHz)
 AM: 530 à 1.710 kHz
 (avec intervalle entre les canaux réglé sur 10 kHz)
 531 à 1.602 kHz
 (avec intervalle entre les canaux réglé sur 9 kHz)

[Syntoniseur FM]

Sensibilité utilisable: 11,3 dBf (1,0 μ V/75 Ω)
 Sensibilité de silence à 50 dB: 16,3 dBf (1,8 μ V/75 Ω)
 Sélectivité de canal voisin: (400 kHz): 65 dB
 Réponse en fréquence: 40 à 15.000 Hz
 Séparation stéréo: 35 dB
 Rapport de capture: 1,5 dB
 [Syntoniseur AM]
 Sensibilité: 20 μ V
 Sélectivité: 35 dB

SECTION CASSETTE

Pleurage et scintillement: 0,11% (WRMS)
 Durée de défilement rapide: 100 s (C-60)
 Réponse en fréquence (sans réduction de bruit): 30 à 16.000 Hz (± 3 dB) (Bande métal/CrO₂)
 30 à 16.000 Hz (± 3 dB) (Bande normale)
 Rapport signal/bruit: (Bande normale) (Dolby NR-ON): 60 dB
 (Dolby NR-OFF): 54 dB
 Séparation stéréo: 40 dB

GENERALES

Alimentation
 Tension de fonctionnement: CC 14,4 volts (11 à 16 volts possible)
 Système de mise à la masse: Masse négative
 Dimensions (L x H x P)
 Taille d'installation: 182 x 52 x 150 mm
 Taille de panneau: 188 x 58 x 14 mm
 Poids brut: 2,2 kg
 Présentation et caractéristiques modifiables sans préavis.

Si un kit est nécessaire pour votre voiture, consulter votre annuaire téléphonique pour chercher le revendeur d'accessoires audio pour automobile le plus proche.

FRANÇAIS

 VICTOR COMPANY OF JAPAN, LIMITED

JVC

KS-RT626

Installation/Connection Manual

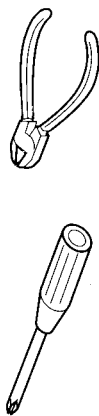

• This unit is designed to operate with 12 volts DC, NEGATIVE ground electrical systems only.

INSTALLATION (IN-DASH MOUNTING)

• The following illustration shows a typical installation. However, you should make adjustments corresponding to your specific car. If you have any questions or require information regarding installation kits, consult your JVC car audio dealer or a company supplying kits.

- ① **Before mounting:** Press the Control Panel Release (▶) button to detach the control panel.
- ② Remove the trim plate.

• **Follow the numbers for mounting.**
(Refer to parts list on the right.)

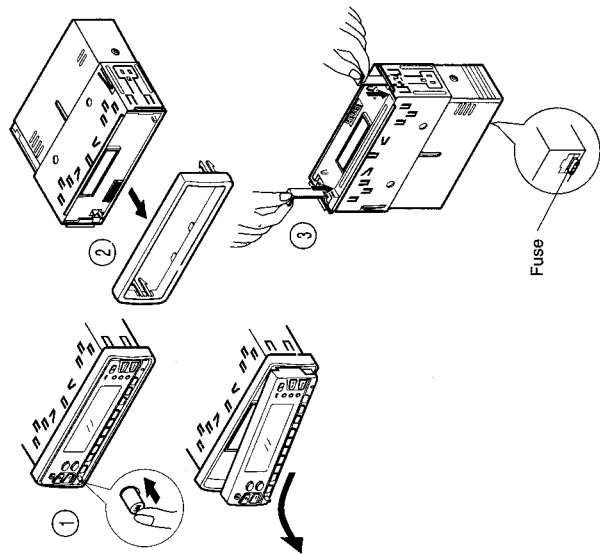

- ③ Stand the unit on end and insert the 2 handles between the unit and the sleeve as shown. Disengage the sleeve lock and remove the sleeve.
- ④ Install the sleeve in the dashboard.
* After the sleeve is correctly installed in the dashboard, bend the appropriate tabs to hold the sleeve firmly in place, as shown.
- ⑤ Fix the mounting bolt to the rear of the unit's body and place the rubber cushion over the end of the bolt.
- ⑥ Slide the unit into the sleeve until they are locked together.
- ⑦ Attach the trim plate.

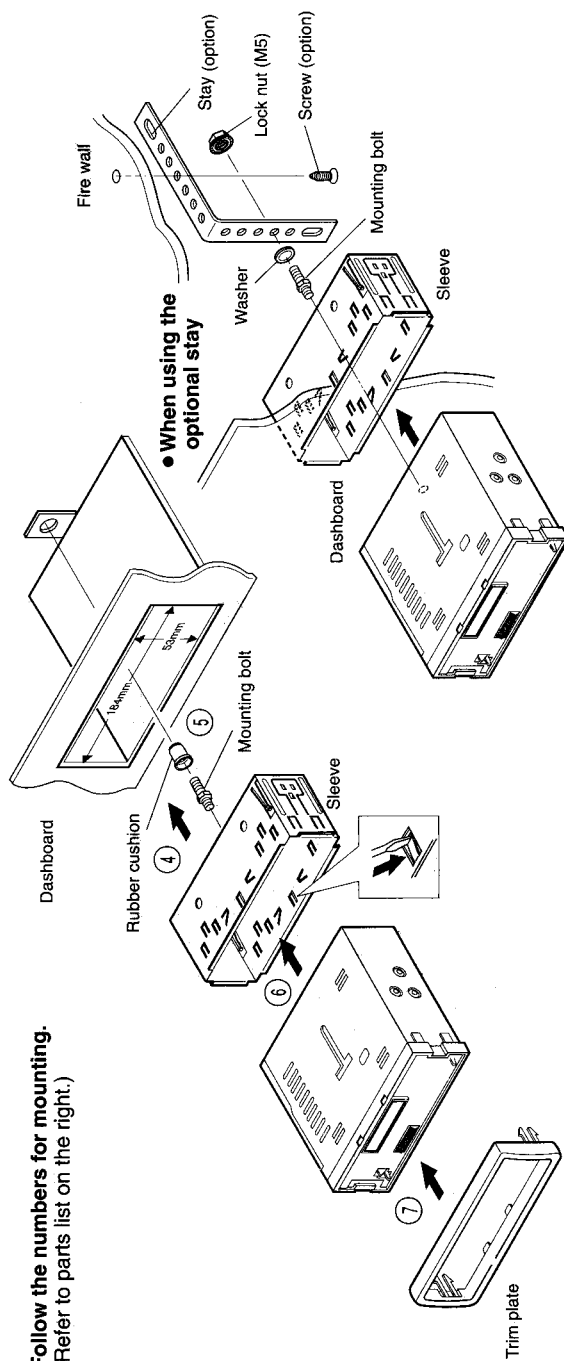

When installing the unit without using the sleeve.

In a Toyota for example, first remove the car radio and install the unit in its place.

* Not included with this product.

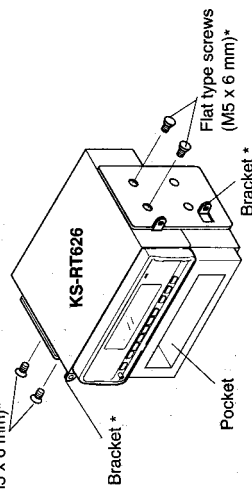

Note:

• When installing the unit on the mounting bracket, make sure to use the 6 mm-long screws. If longer screws are used, they could damage the unit.

Removing the unit

• Before removing the unit, release the rear section.

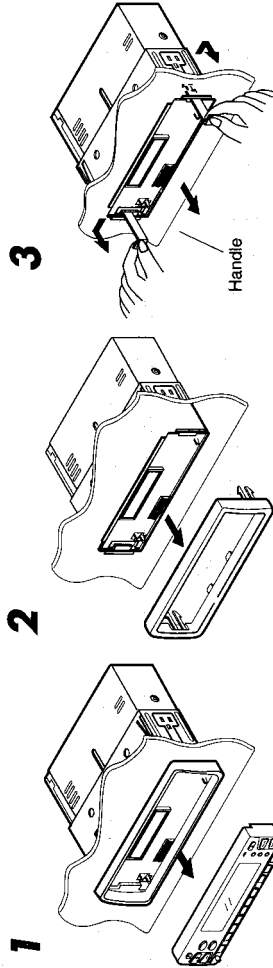

Remove the control panel.

Remove the trim plate.

Insert the 2 handles into the slots, as shown. Then, while gently pulling the handles away from each other, slide out the unit. (Be sure to keep the handles after installing it.)

Installation (Remote controller)

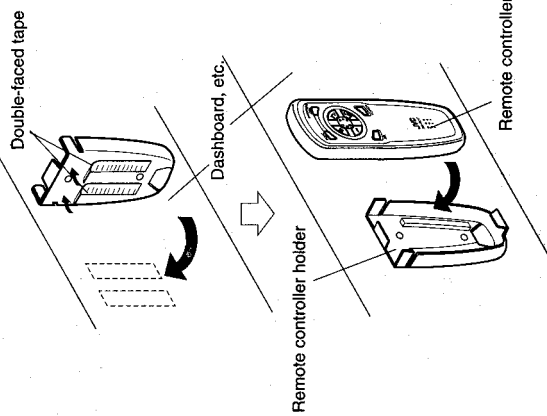

• Wipe clean the place where the double-faced tape is to be attached before attaching it.

Parts list for installation and connection

The following parts are provided with this unit. After checking them, please set them correctly.

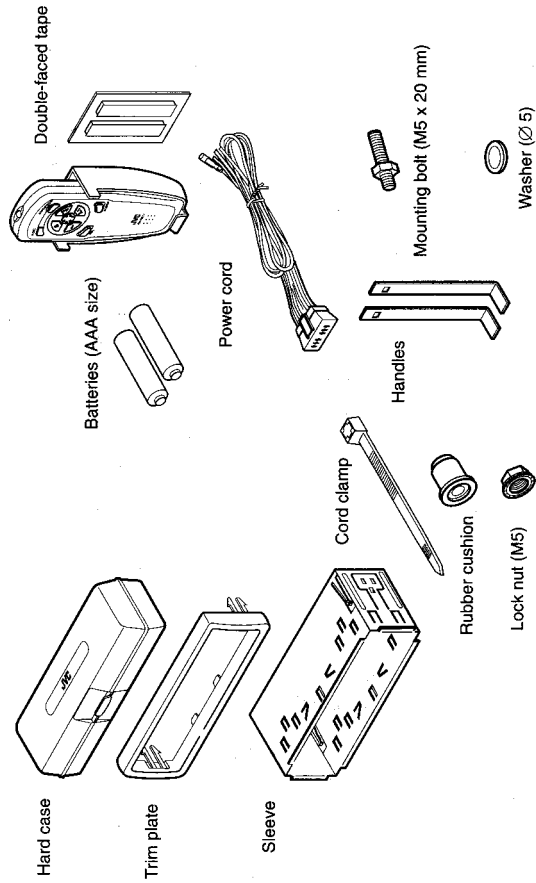

ENGLISH

ELECTRICAL CONNECTIONS

To prevent short circuits, we recommend that you disconnect the battery's negative terminal and make all electrical connections before installing the unit. If you are not sure how to install this unit correctly, have it installed by a qualified technician.

Note:

This unit is designed for a 12-volt DC negative ground. If your vehicle does not have this system, a voltage inverter is required, which can be purchased at JVC car audio dealers.

- Replace the fuse with one of the specified rating. If the fuse blows frequently, consult your JVC car audio dealer.
- If noise is a problem...
This unit incorporates a noise filter in the power circuit. However, with some vehicles, clicking or other unwanted noise may occur. If this happens, connect the unit's **rear ground terminal** (See connection diagram below.) to the car's chassis using shorter and thicker cords, such as copper braiding or gauge wire. If noise still persists, consult your JVC car audio dealer.
- Maximum input of the speakers should be more than 40 watts at the rear and 40 watts at the front, with an impedance of 4 to 8 ohms.
- **Be sure to ground this unit to the car's chassis.**
- During regular operation, the heat sink becomes very hot. Be careful when handling it.

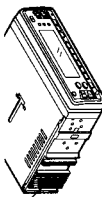

Heat sink

TROUBLESHOOTING

- **The fuse blows.**
 - * Are the red and black leads connected correctly?
- **Power cannot be turned on.**
 - * Is the yellow lead connected?
- **No sound from the speakers.**
 - * Is the speaker output lead short-circuited?
- **Sound is distorted.**
 - * Is the speaker output lead grounded?
 - * Are the "L" terminals of L and R speakers grounded in common?
- **Unit becomes hot.**
 - * Is the speaker output lead grounded?
 - * Are the "L" terminals of L and R speakers grounded in common?

A.4-Speaker Connections

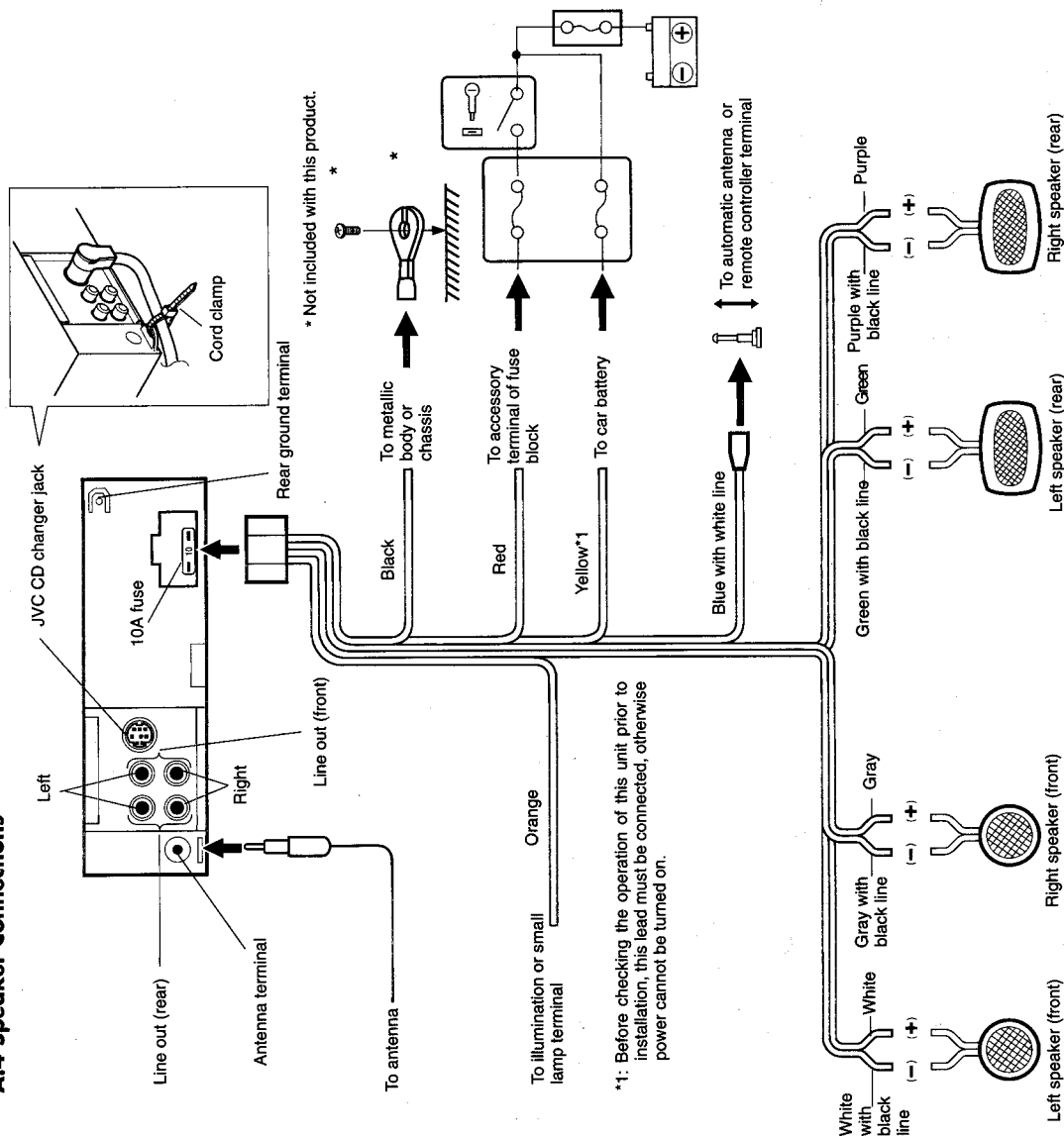

B.4-Speaker connections when adding a power amplifier

Since this unit has line-out terminals, an amplifier and other equipment can be used to upgrade your car stereo system.

- With an amplifier, connect this unit's line-out terminals to the amplifier's line-in terminals.

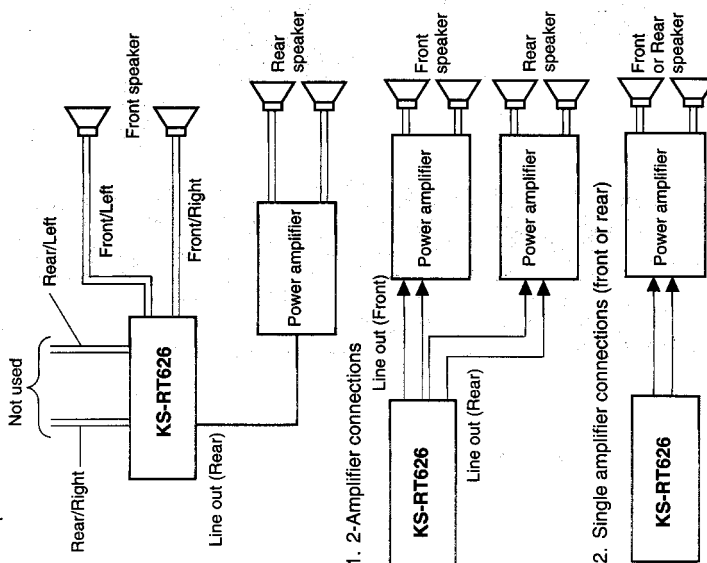

Switching the unit's built-in amp ON/DEFEAT
When an external amp is connected, the unit's built-in amp can be switched off, to send sound to the external amp only, lowering heat generation to a minimum and allowing clear sound to be reproduced.

C. Automatic Antenna Connections

To use the automatic antenna, connect its remote lead (blue with white line) terminal. For details of installation, see the automatic antenna's Instruction Manual.

D. Memory Back-Up Lead

Connect this lead (yellow) to a LIVE power source (supplied even when vehicle ignition is OFF).

Connecting the wires

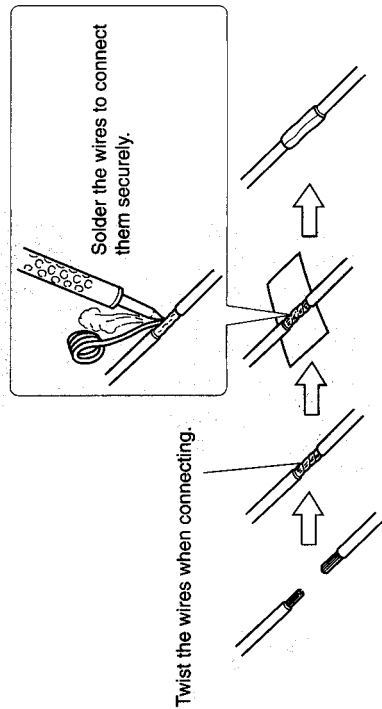

CAUTIONS:
As this unit uses BTL (Balanced Transformerless) amplifier circuitry (floating ground system), please comply with the following:

1. Do NOT connect the black-lined speaker leads to a common point (Fig. a).
2. Do NOT connect the speaker leads to the metal body or chassis (Fig. b).
3. Cover the terminals of the leads that are NOT used with insulating tape, to prevent them from shorting (Fig. c).

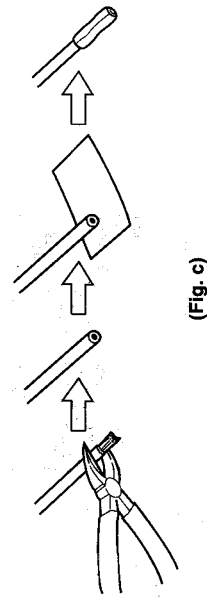
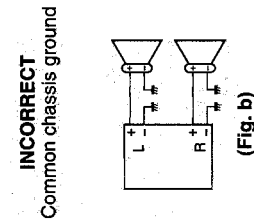
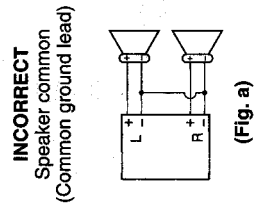

1 Location of main parts

◆ Control unit

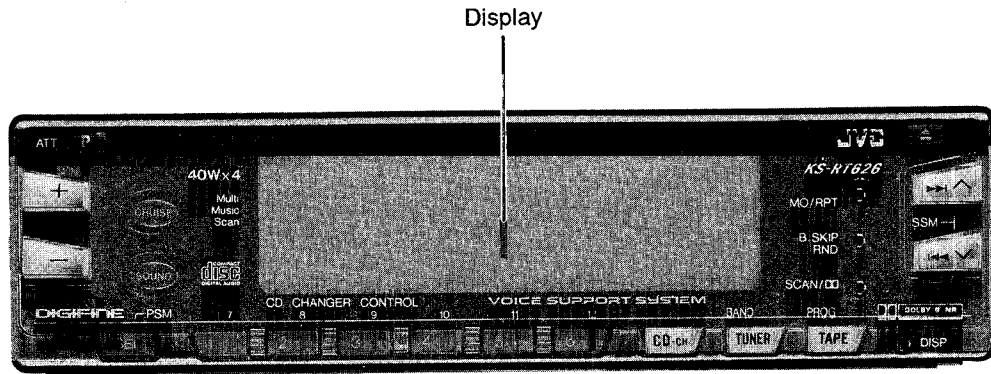

Fig. 1-1

◆ Top shassis and mechanism section

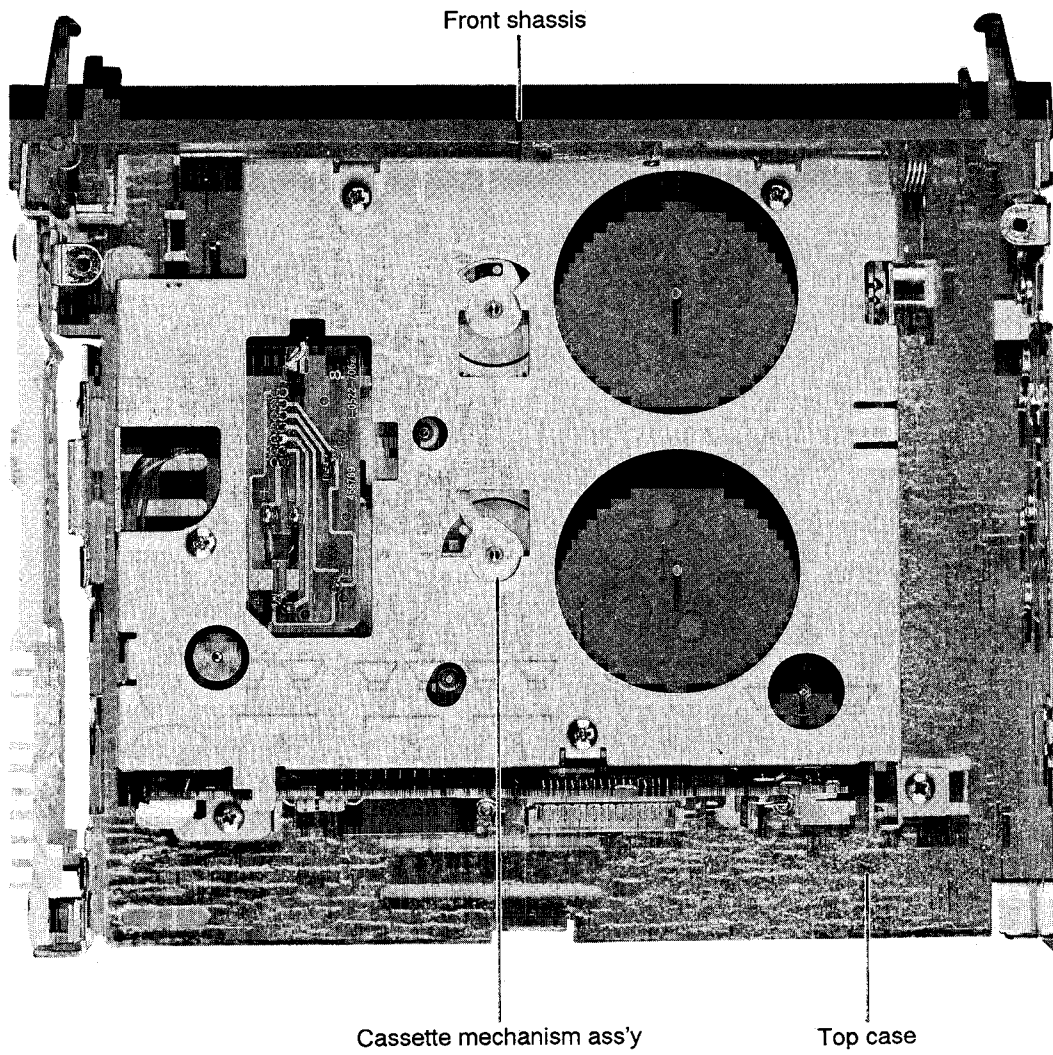

Fig. 1-2

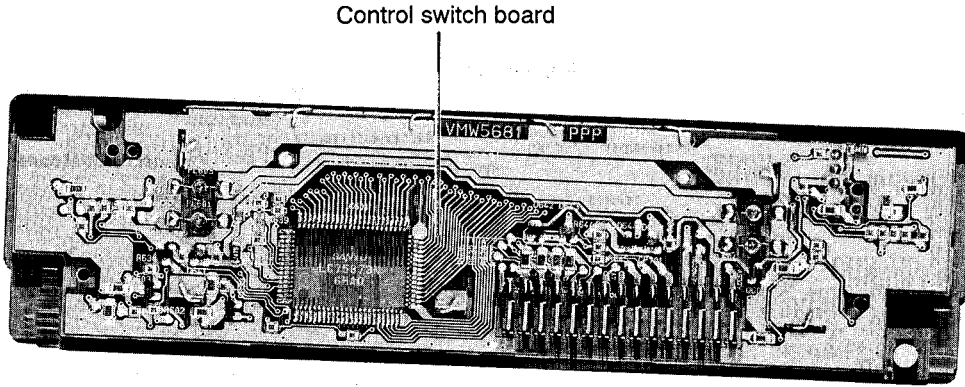

Fig. 1-3

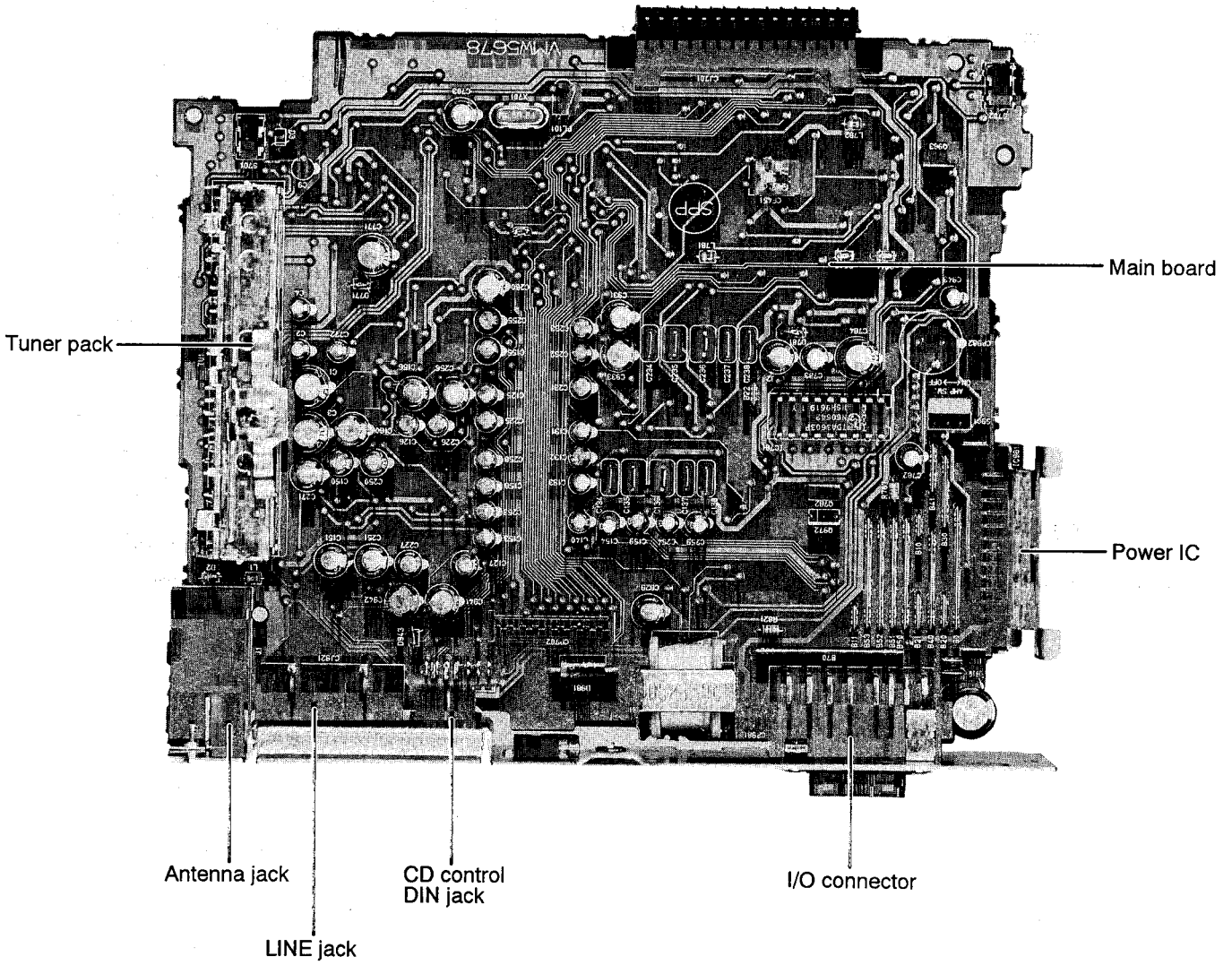

Fig. 1-4

2 Removal of main parts

■ Enclosure sections

◆ Control panel unit (see fig 2-1~ fig 2-2)

1. Press the Eject button to open the control panel unit.
2. Push and open the right and left open/close shaft arms outward to remove the shaft .
3. Remove the control panel unit from the same side as the shaft was removed.

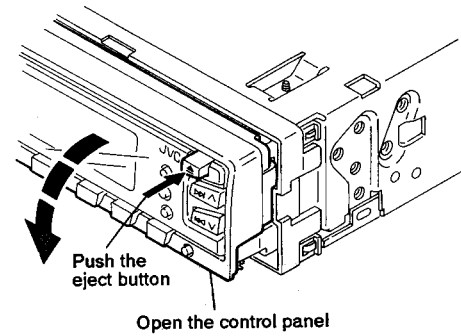

Fig. 2-1

◆ Front Chassis Ass'y (See fig 2-3 ~ fig 2-4)

1. Remove the control panel unit.
2. Remove the two screws ㉓ securing the front chassis ass'y.
3. Remove the four pawls ㉔ securing the front chassis ass'y to the chassis.

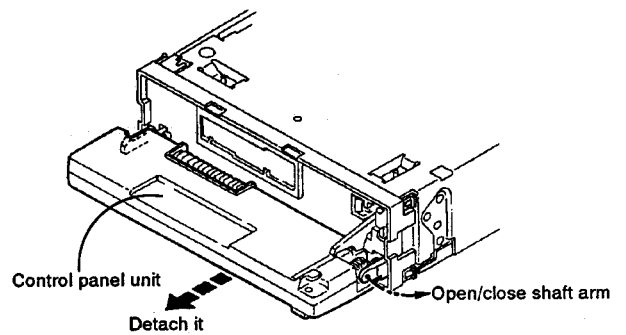

Fig. 2-2

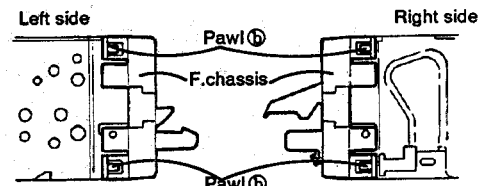

Fig. 2-3

◆ Removing the bottom cover (See Fig. 2-5)

Turn the unit upside down, then insert and turn the screwdriver to remove the bottom cover.

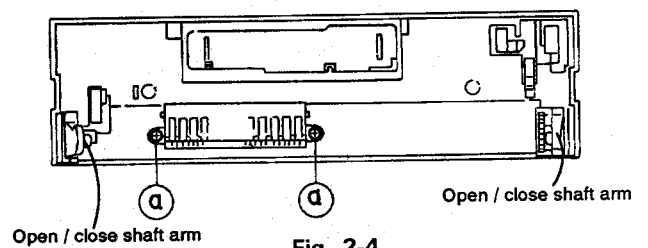

Fig. 2-4

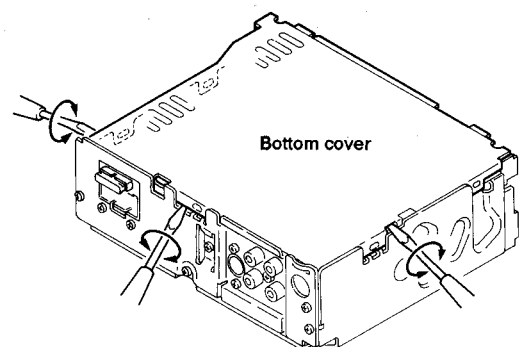

Fig. 2-5

◆ **Removing the main P.C.B. assembly (with rear panel)** (See Fig. 2-6~2-8)

1. Remove two screws ④ retaining the rear panel to the chassis.
2. Remove one screw ② retaining the IC to the heat sink.
3. Remove two screws ③ retaining the amp. P.C.B. assembly.
4. Lift up the main P.C.B. assembly to remove it. At this time, remove the connector CP702 connecting the main P.C.B. assembly and mechanism assembly.
5. Remove two screws ① to remove the heat sink.

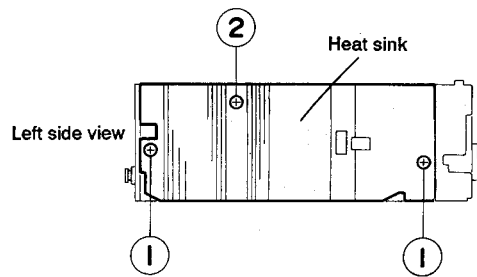

Fig. 2-6

◆ **Removing the rear panel** (See Fig. 2-7)

- Remove six screws retaining the jacks or the like.
 Remove two screws ⑤ to remove the 16-pin jack.
 Remove one screw ⑥ to remove the line-out jack.
 Remove one screw ⑦ to remove the antenna jack.
 Remove two screws ⑧ to remove the changer controller jack.

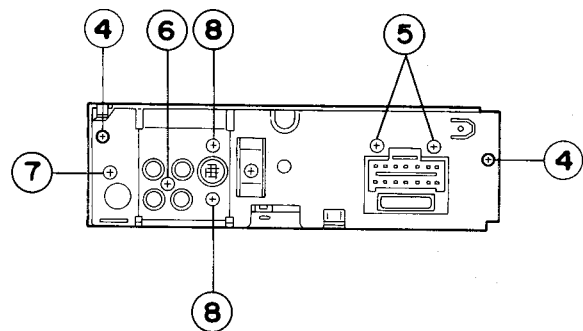

Fig. 2-7

◆ **Mechanism assembly** (See Fig. 2-9)

- Remove four mechanism mounting screws ⑨ retaining the top cover.

◆ **Front panel unit.** (See Fig. 2-10)

- Remove four screws ⑩ retaining the rear cover.

Connection to the mechanism connector position.

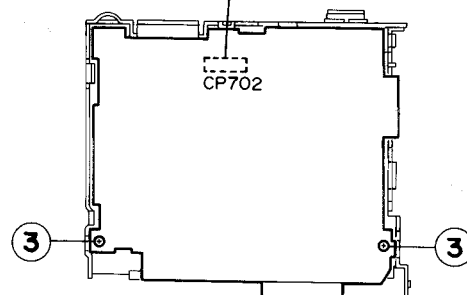

Fig. 2-8

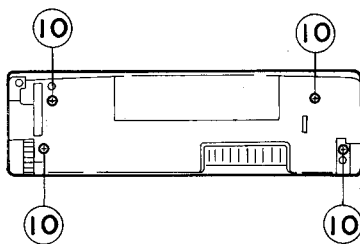

Fig. 2-10

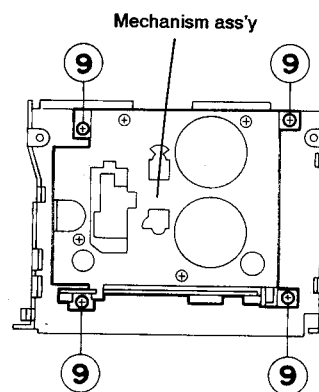

Fig. 2-9

■ Cassette mechanism section

■ Mechanism section

◆ Removing the head relay PCB

1. Desolder the lead wires of the loading motor at the 2 positions shown (red, black). (Fig. 2-8)
2. Desolder the lead wires of the head at the 3 positions shown (red, yellow, black). (Fig. 2-8)
3. Remove the three screws ① securing the head relay PCB. (Fig. 2-8)
4. Shift the interlocking section ② securing the head relay PCB in the direction shown by the arrow A to remove the PCB. (Fig. 2-8)

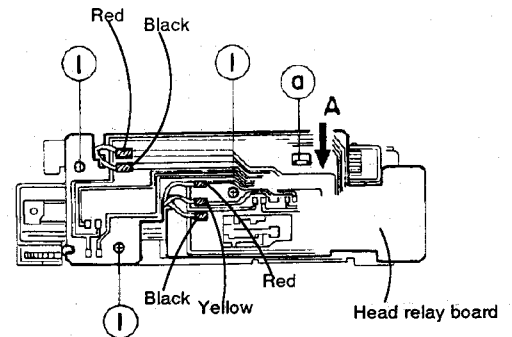

Fig. 2 - 8

◆ Removing the load arm assembly

1. Using tweezers, detach the Mylar washer ⑥ securing the load arm assembly and pull out the load arm assembly. (Fig. 2-9)

Note: When reassembling, be sure to use a new Mylar washer.

2. Shift the load arm assembly counterclockwise. (Fig. 2-9)
3. Remove the load arm assembly from the catch (K). (Fig. 2-9)

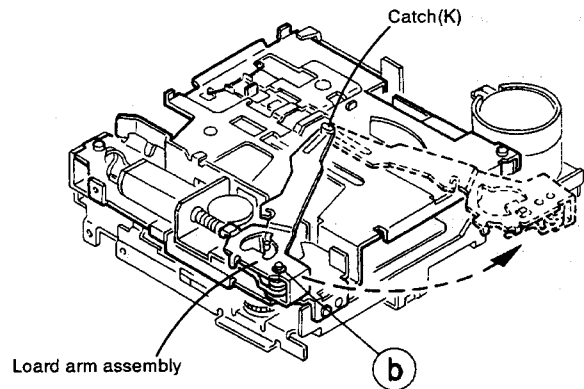

Fig. 2 - 9

◆ Removing the cassette holder and holder arm assembly

1. Remove the head relay PCB.
2. Remove the load arm assembly.
3. Apply DC 6 V to the lead wire of the loading motor assembly and turn the load gear assembly to the position shown in Fig. 2-10.
4. Remove the screw ② securing the cassette holder and holder arm assembly. (Fig. 2-10)
5. Shift the cassette holder and the holder arm assembly in the direction shown by the arrow B and remove them from the interlocking section ③ of the sub chassis assembly. (Fig. 2-10)

◆ Removing the sub chassis assembly

1. Remove the head relay PCB.
2. Remove the load arm assembly.
3. Remove the cassette holder and holder arm assembly.
4. Remove the two screws ③ and ④ securing the sub chassis assembly. (Fig. 2-10)

Note: When removing the sub chassis assembly, the mode gear may become detached. In this case, set it back to the original position.

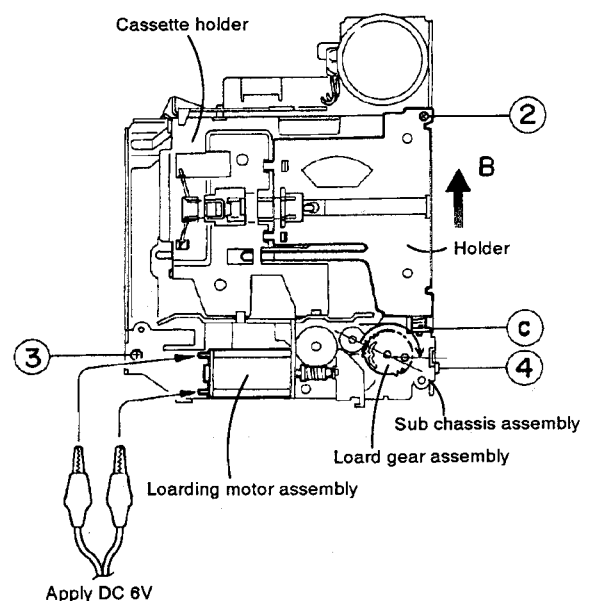

Fig. 2 - 10

◆ **Removing the play head** (Fig. 2-11)

1. Remove the head relay PCB.
2. Remove the load arm assembly.
3. Remove the cassette holder and holder arm assembly.
4. Remove the sub chassis assembly.
5. Disengage the spring holding the play head down.
6. Remove the two screws ⑤ securing the play head.

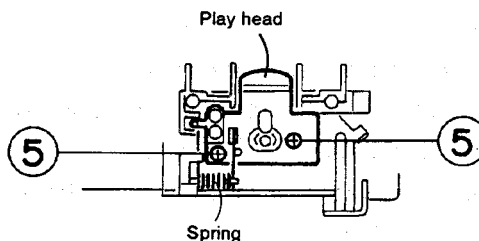

Fig. 2 - 11

◆ **Removing the pinch roller assembly**

(Figs. 2-12 and 13)

1. Remove the head amp PCB.
2. Remove the load arm assembly.
3. Remove the cassette holder and holder arm assembly.
4. Remove the sub chassis assembly.
5. Detach the Mylar washers @ at the two positions securing the right and left pinch roller assemblies.

Note: When reassembling, be sure to use new Mylar washers. Also, make sure that grease is not adhering to the pinch rollers.

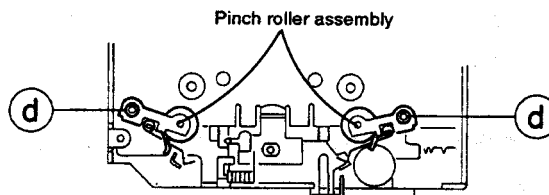

Fig. 2 - 12

6. Pull out the pinch rollers.

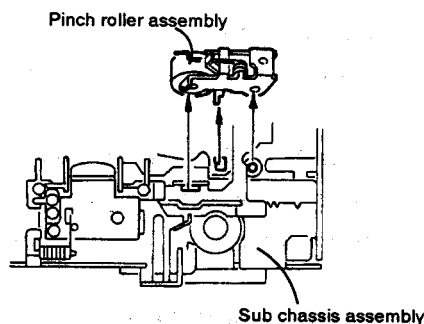

Fig. 2 - 13

◆ **Removing the reel disk assembly** (Fig. 2-14)

1. Remove the head amp PCB.
2. Remove the load arm assembly.
3. Remove the cassette holder and holder arm assembly.
4. Remove the sub chassis assembly.
5. Detach the Mylar washer ⑥ from the tip by first pressing down the reel feather to expose it.

Note: When reassembling, be sure to use a new Mylar washer.

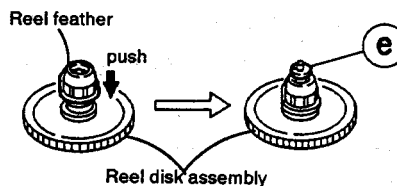

Fig. 2 - 14

◆ **Removing the head plate (Figs. 2-15 and 16)**

1. Remove the head amp PCB.
2. Remove the load arm assembly.
3. Remove the cassette holder and holder arm assembly.
4. Remove the sub chassis assembly.
5. Remove the right and left pinch roller assembly.
6. From the rear of the head plate, detach the Mylar washer ① and the washer pressing the forward/reverse plate down. (Fig. 2-15)
7. Remove the screw ⑥ fixing the metal detection lever and removal spring as shown in Fig. 2-15.
8. Remove the head plate.
9. Pull out the mode gear. (Fig. 2-16)

Note: When installing the mode gear, set it to the arrow mark.

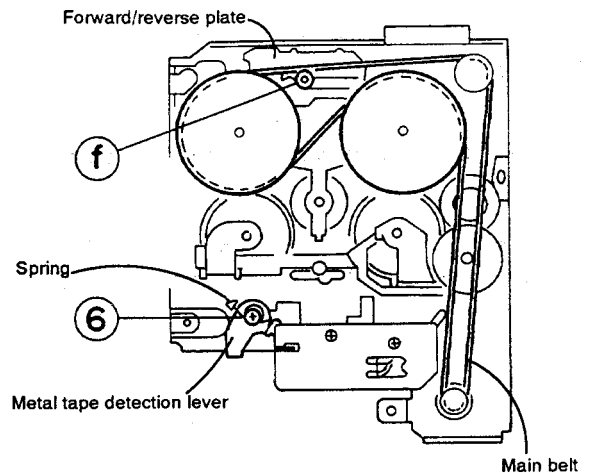

Fig. 2 - 15

◆ **Removing the flywheel assembly (Fig. 2-16)**

1. Remove the head relay PCB.
2. Remove the load arm assembly.
3. Remove the cassette holder and the holder arm assembly.
4. Remove the sub chassis assembly.
5. Remove the head plate.
6. Disengage the main belt from the flywheel assembly. (Fig. 2-15)
7. Remove E washers ⑧ at the two positions which secure the capstan shaft away from the surface. (Fig. 2-16)
8. Pull out the flywheel assembly from the rear.

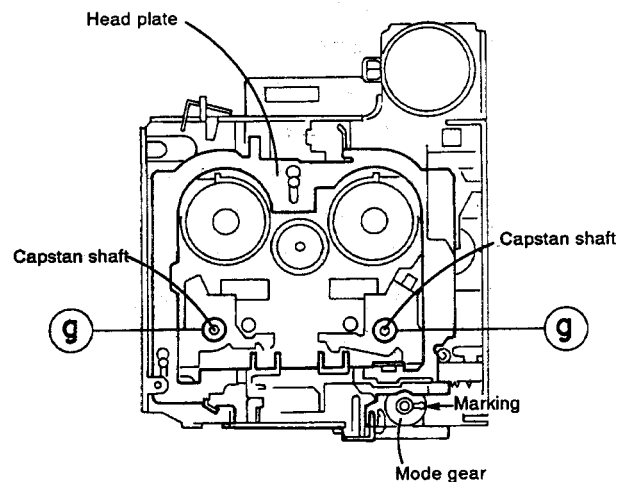

Fig. 2 - 16

◆ **Removing the reel disk PCB**

1. Remove the head relay PCB.
2. Remove the load arm assembly.
3. Remove the cassette holder and the holder arm assembly.
4. Remove the sub chassis assembly.
5. Straighten the curved tab ⑨ securing the reel disk PCB. (Fig. 2-17)
6. Remove the two screws ⑦ fixing the reel disc PCB. (Fig. 2-17)
7. Remove the reel disk PCB.

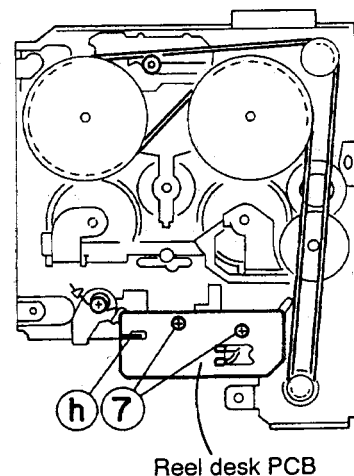

Fig. 2 - 17

◆ **Removing the loading motor assembly**

1. Remove the head relay assembly.
2. Remove the load arm assembly.
3. Remove the Mylar washer ① fixing the worm gear. (Fig.2-18)

Note: When reassembling, be sure to use a new Mylar washer.

4. Remove the screw ⑧ fixing the loading motor assembly. (Fig. 2-18)
5. Remove the two screws ⑨ fixing the loading motor assembly. (Fig. 2-18)

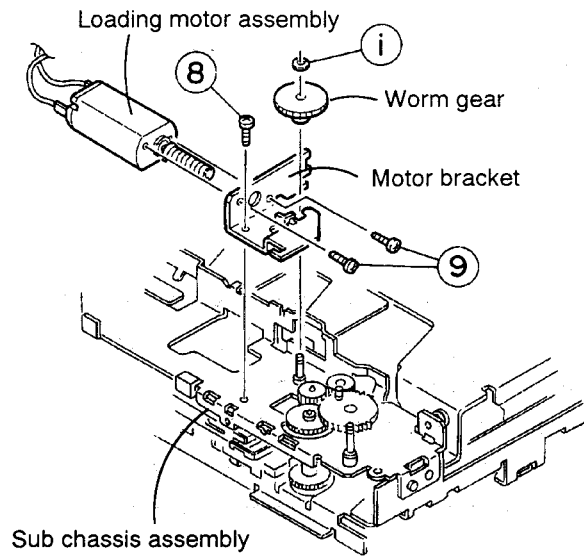

Fig. 2 – 18

● **(Procedures for reassembling)**

1. Insert the mode gear into the sub chassis assembly.
2. Install the sub chassis assembly and secure it with the two screws ③ and ④ as shown in (Fig. 2-19).

Note: The set arm assembly and the mode gear should be positioned as shown in Fig. 2-19.

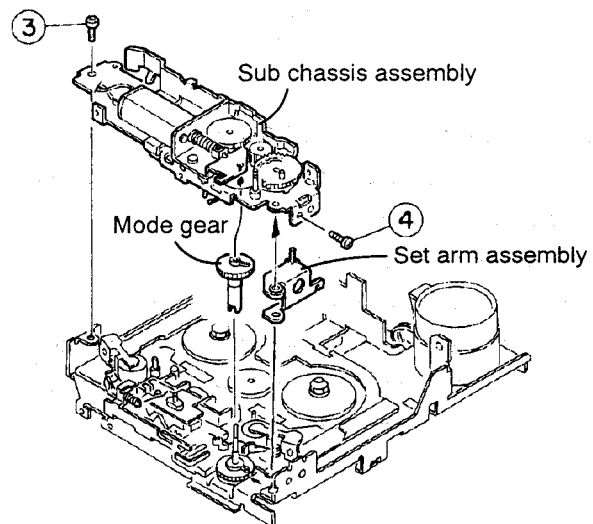

Fig. 2 – 19

3. Attach the cassette holder as shown in Fig. 2-20. In this case, first pass the tab of the section ① through the mechanism ②, then attach the cassette holder in the direction shown by the arrow.

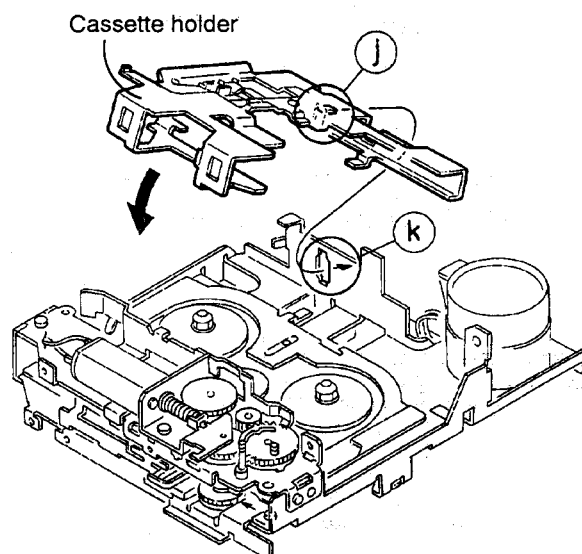
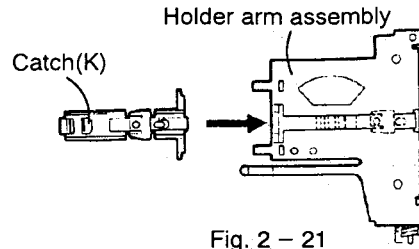
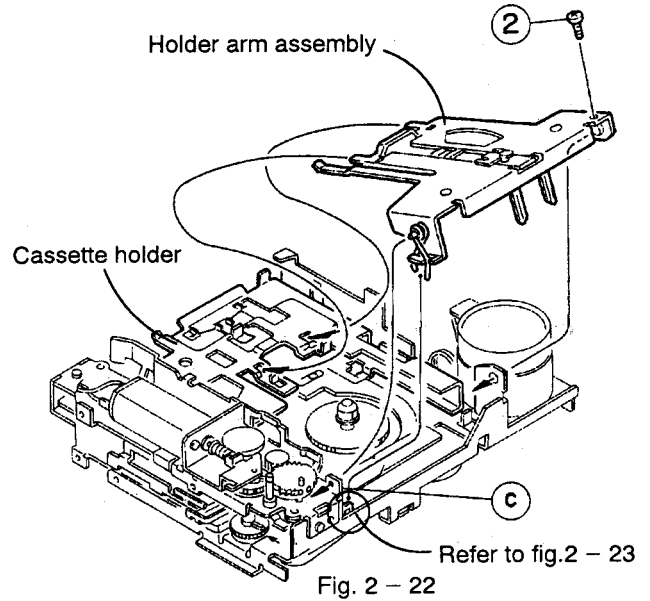

Fig. 2 – 20

- Set the catch (K) to the holder arm assembly as shown in Fig. 2-21.



- While attaching the holder arm assembly to the cassette holder, insert the shaft of the holder arm assembly into the interlocking section © of the sub chassis assembly as shown in Fig. 2-22.
- Install the spring attached to the holder arm assembly shaft over the set arm assembly as shown in Fig. 2-23.
- After the holder arm assembly is installed, secure it with the screw ②. (Fig. 2-22)



- After the installation, apply DC 6 V to the lead wires of the loading motor assembly to locate the load gear assembly as shown in Fig. 2-24.
- Install the load arm assembly.
- Install the head relay PCB.

Note: Install it so that the slide switch lever of the head relay PCB is set in the PCB stay hook of the sub chassis assembly. (Fig. 2-25a)

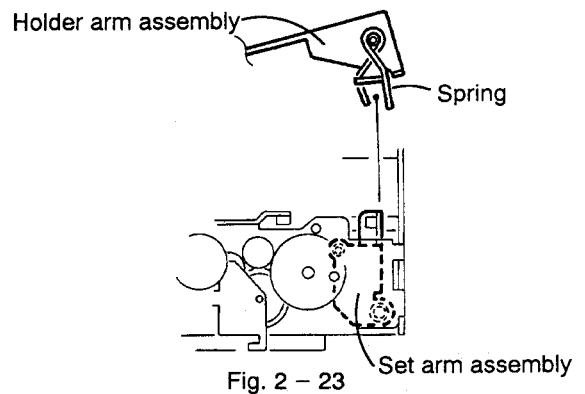
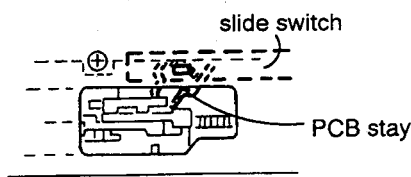

- Solder the loading motor and head lead wires to the head relay PCB, respectively. (Fig. 2-25)

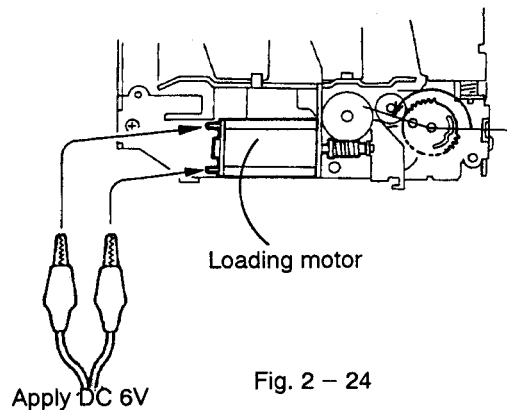
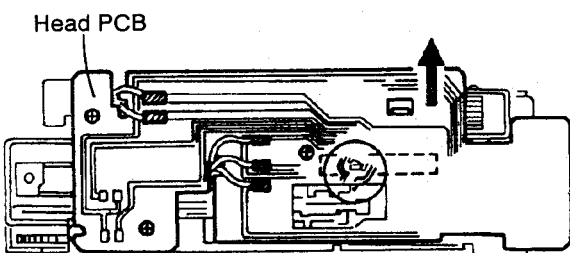

3 Main adjustment

■ Equipment and measuring instruments used for adjustment

- Electronic voltmeter
- Audio frequency oscillator
(range:50~20kHz and output 0 dB with impedance of 600 Ω)
- Attenuator(impedance;600 Ω)
- Frequency counter
- AM Standard signal generator
- FM Standard signal generator
- Wow flutter mater
- Torqu testing cassette gauge
CTG – N (mechanical adjusting)
TW – 2111A (FWD play)
TW – 2121A (REV play)
- Standard tape
VT712 or VTT712(tape speed,wow&flutter adj.)
VT724 or VTT724(reference level)
VT738 or VTT736(playback frequency response)
VT721 or VTT721(output level)
VT703 or VTT703 (azimuth) (10kHz part only)

■ Condition for measurement

- Power Supply DC14.4V
(Reduced Voltage:10.5V)
- Load 4 Ω
(4- speakers connection)
- BASS/TRE, FADER Indication 0
- Main volume Position with an output level of 2V during VTT721 playback
- Tuner section
- **[FM]**;400Hz, 22.5kHz deviation(MONO)
- **[FM]**STEREO ;1kHz, 67.5kHz deviation, pilotsignal 7.5kHz, 66dB μ V
- **[AM]**;400Hz, 30% modulation ,74dB μ V
- Output impedance ;50 Ω

■ Dummy antenna

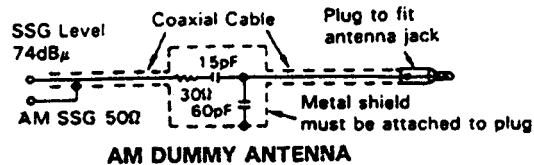
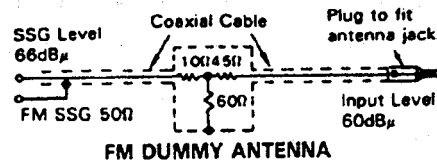

● Preset memory Initialization

Band	Preset Memory					
	M1	M2	M3	M4	M5	M6
FM(MHz)	87.5	89.9	97.9	105.9	107.9	87.5
AM(kHz)	530	600	1000	1500	1710	530

● Manual Tuning Up/Down Frequency

- [FM]**;200kHz Step
- [AM]**;10kHz Step

■ **Information for using a Car Stereo service jig (for adjustment and checking)**

◆ For 1995 and 1996, we're advancing efforts to make our extension cords common for all Car Stereo products.

Please use this type of extension cord as follows.

◆ As a U - shape type top cover is employed, this type of extension cord is needed to check operation of the mechanism assembly after disassembly.

◆ Extension cords

EXT - KSRT002 - 18P (18 pin extension cord)

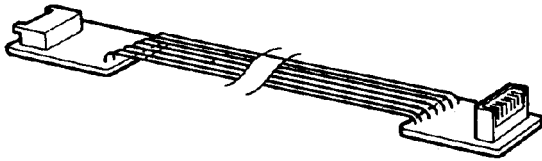

For connection between mechanism assembly and main PCB assembly.

Check for mechanism-driving section such as motor, etc.

◆ Disassembly method (Refer to method to remove main parts)

1. Remove the bottom cover.
2. Remove the front panel assembly.
3. Remove the top cover. (Remove the screws at each side of heat sink and rear panel.)
4. Install the front panel (whose assembly was removed in step 2) to the main unit.
5. Confirm that current is being carried by connecting an extension cord jig.

◆ Connection diagram

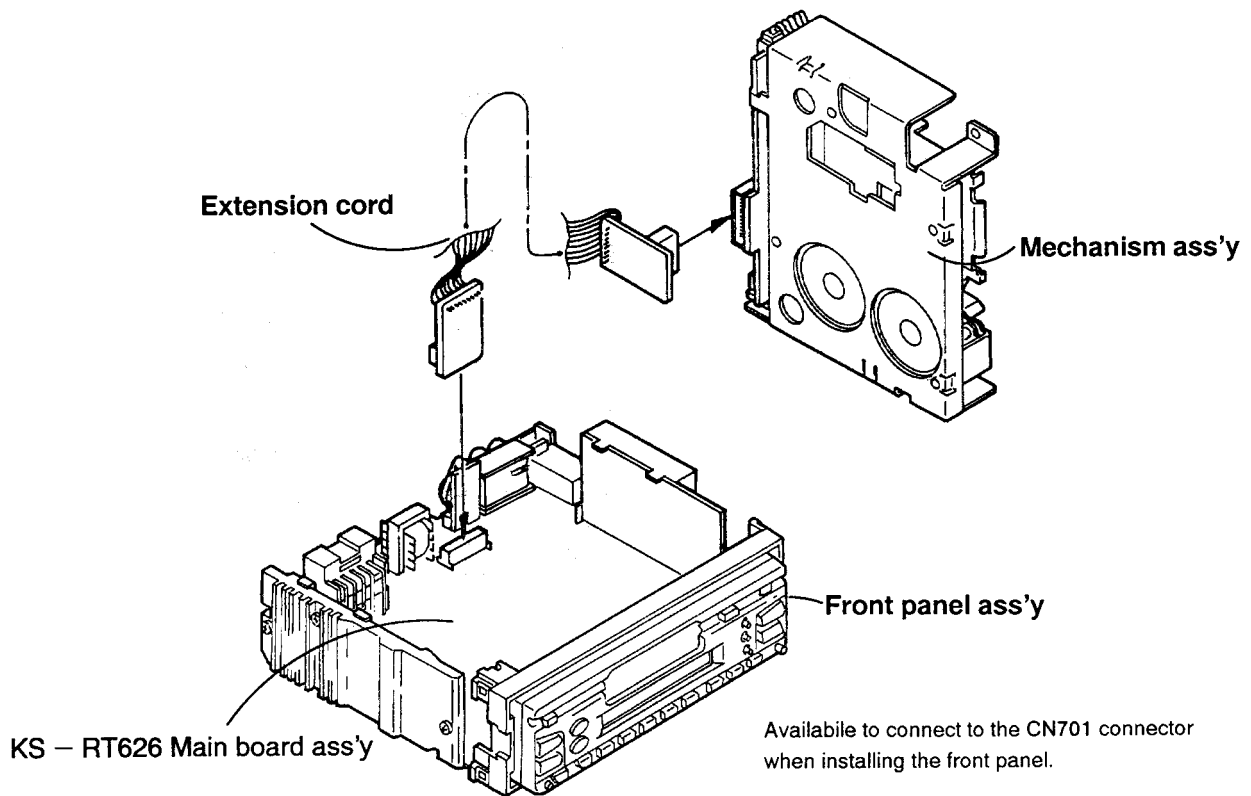

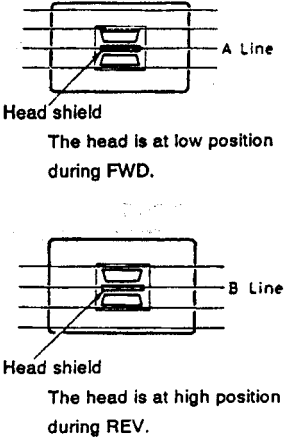
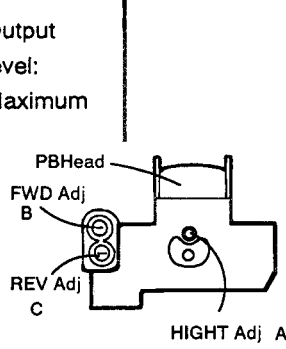
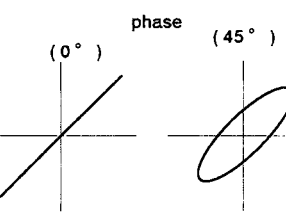
Item	Conditions	Adjustment and Confirmation methods	S.Values	Adjust
<p>1. Head azimuth adjustment</p>	<p>Test tape: SCC - 1659 VT703(10kHz)</p>	<p>◆ Head height adjustment ※ Adjust the azimuth directly. When you adjust the height using a mirror tape, remove the cassette housing from the mechanism chassis. After installing the cassette housing, perform the azimuth adjustment.</p> <ol style="list-style-type: none"> 1. Load the SCC- 1659 mirror tape. Adjust with height adjustment screw A and azimuth adjustment screw B so that line A of the mirror tape runs in the center between Lch and Rch in the reverse play mode. 2. After switching from REV to FWD then to REV, check that the head position set in procedure 1 is not changed. (If the position has shifted, adjust again and check.) 3. Adjust with azimuth adjustment screw B so that line B of the mirror tape runs in the center between Lch and Rch in the forward play mode. <p>◆ Head azimuth adjustment</p> <ol style="list-style-type: none"> 1. Load VTT724 (VT724) (1 kHz) and play it back in the reverse play mode. Set the Rch output level to max. 2. Load VTT703 (VT703) (10 kHz) and play it back in the forward play mode. Adjust the Rch and Lch output levels to max. with azimuth adjustment screw B. In this case, the phase difference should be within 45° 3. Engage the reverse mode and adjust the output level to max. with azimuth adjustment screw C. (The phase difference should be 45° or more.) 4. When switching between forward and reverse modes, the difference between channels should be within 3 dB. (Between FWD L and R, REV L and R) 5. When VTT721 (VT721) (315 Hz) is played back, the level difference between channels should be within 1.5 dB. 	<p>S.Values</p>	<p>Adjust</p> <div style="text-align: center;">  <p>Head shield The head is at low position during FWD.</p> <p>Head shield The head is at high position during REV.</p> </div> <div style="text-align: center;">  <p>Output level: Maximum</p> </div> <div style="text-align: center;">  <p>phase (0°) (45°)</p> </div>
<p>2. Tape speed and wow flutter confirmation</p>	<p>Test tape:VTT712 (3kHz)</p>	<ol style="list-style-type: none"> 1. Check to see if the reading of the F. counter/wow flutter meter is within 3015~3045(FWD/REV), and less than 0.35% (JIS RMS) . 2. In case of out of specification, adjust the motor with a built-in volume resistor. 	<p>Tape speed: 3015 ~3045Hz Wow flutter:less than0.35%</p>	<p>Built-in volume resistor</p>
<p>3. Playback frequency response confirmation</p>	<p>Test tape:VTT724 (1kHz) VTT739 (63Hz/1kHz/10kHz)</p>	<ol style="list-style-type: none"> 1. Play test tape VTT724, and set the volume position at 2 V 2. Play test tape VTT739 and confirm 1kHz/10kHz: - 1 ± 3dB, 1kHz/63Hz: 0 ± 3dB. 3. When 10 kHz is out of specification, it will be necessary to read adjust the azimuth 	<p>Speaker out 1kHz/63Hz :0 ± 3dB 1kHz/10kHz : - 1 ± 3dB</p>	

The tuner section is of an adjustment-free design. In case the tuner is in trouble, replace the tuner pack.

4 Wiring connections

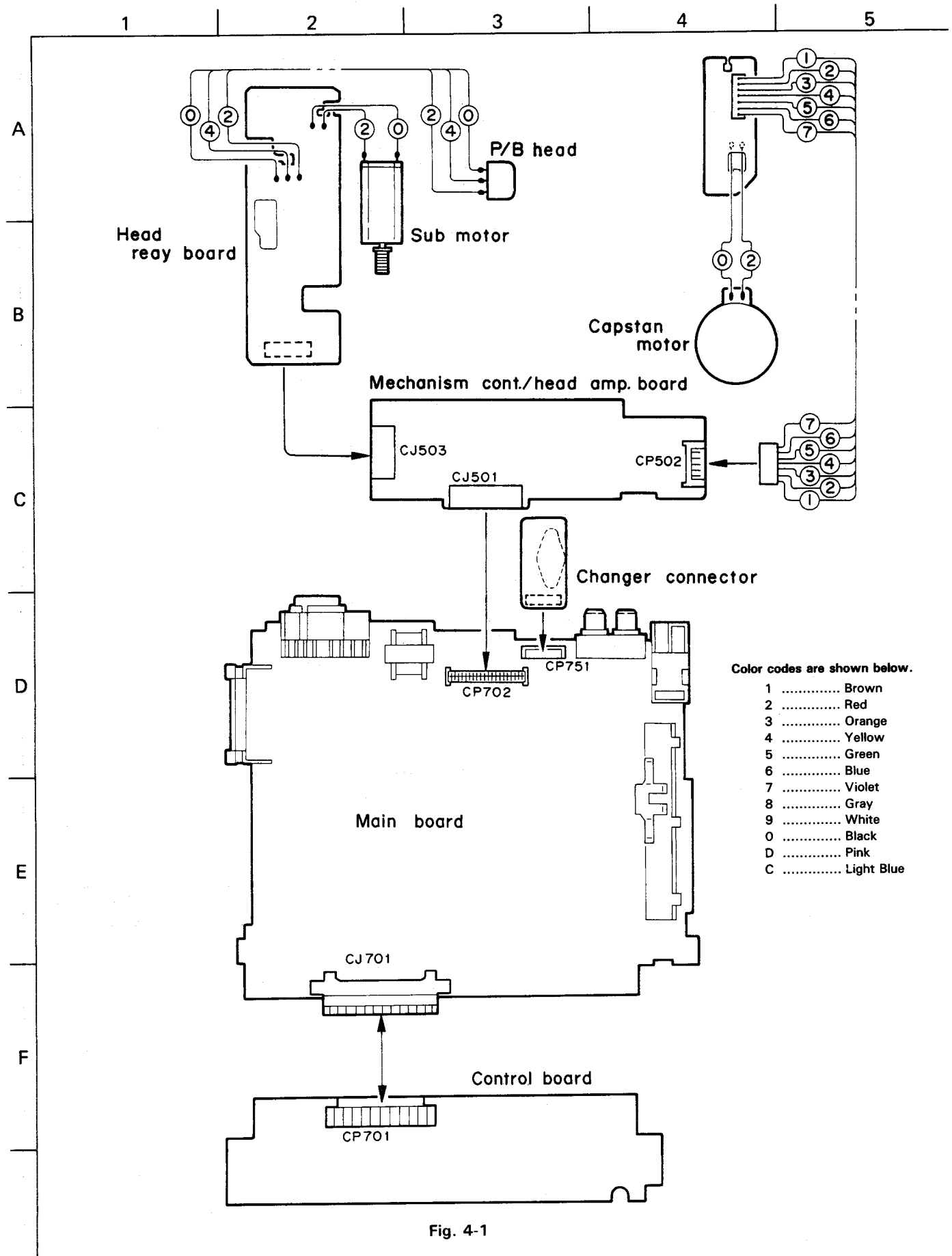

Fig. 4-1

5 Block diagram

Integrated circuit

◆ IC781 (TDA3603P) P. supply

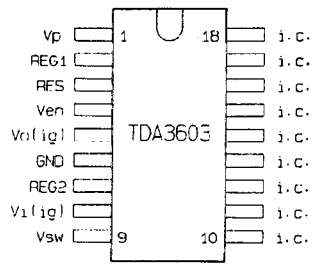
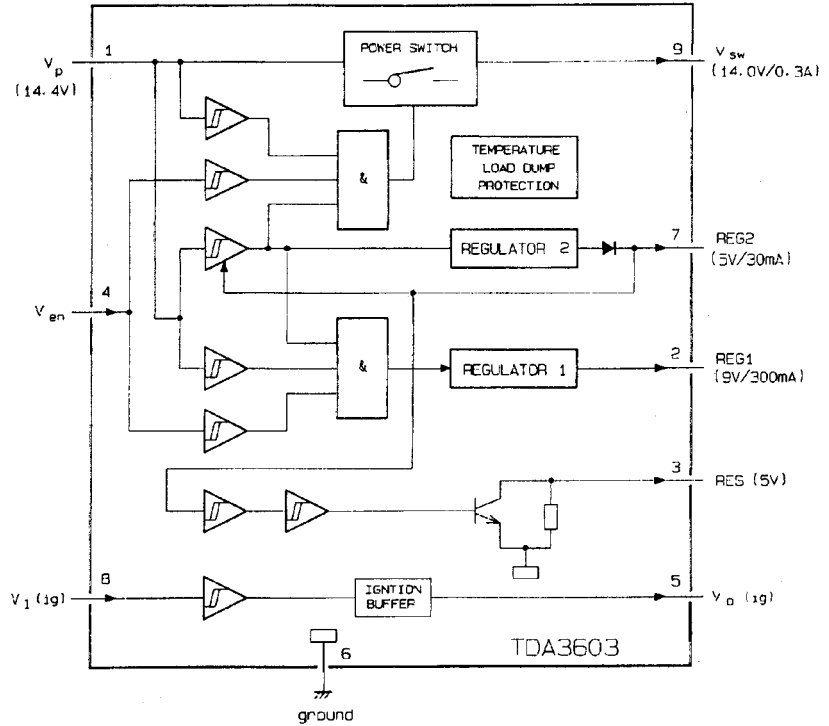

Fig. 5-1



◆ IC981 (TDA8567Q) power amp.

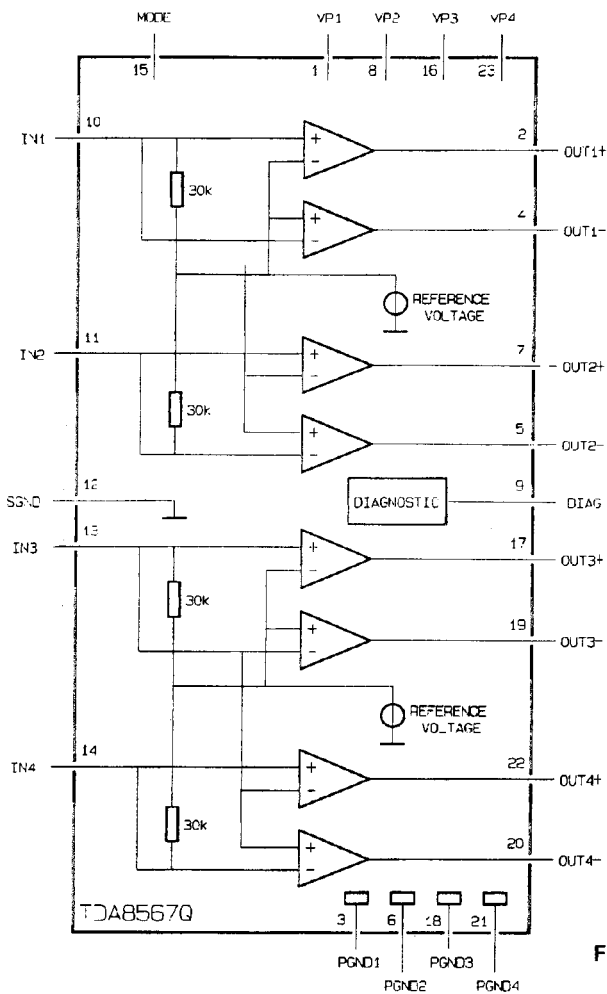

Fig. 5-2

◆ IC120 (NJM4565)

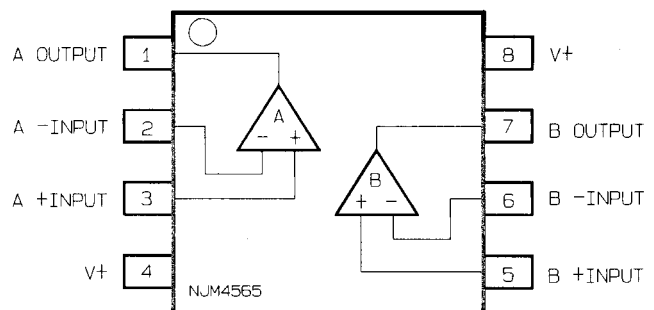

Fig. 5-3

◆ IC451 (UPD7758AGT) voice

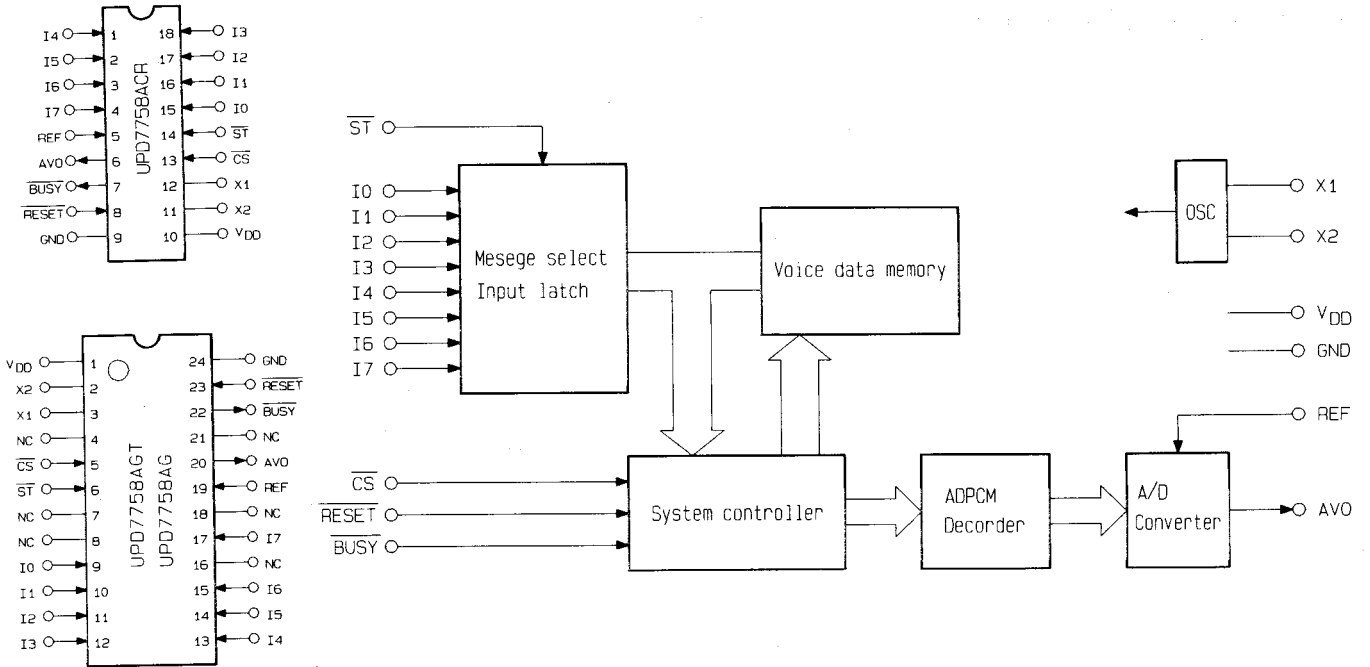

Fig. 5-4

◆ IC501 (LB1641)

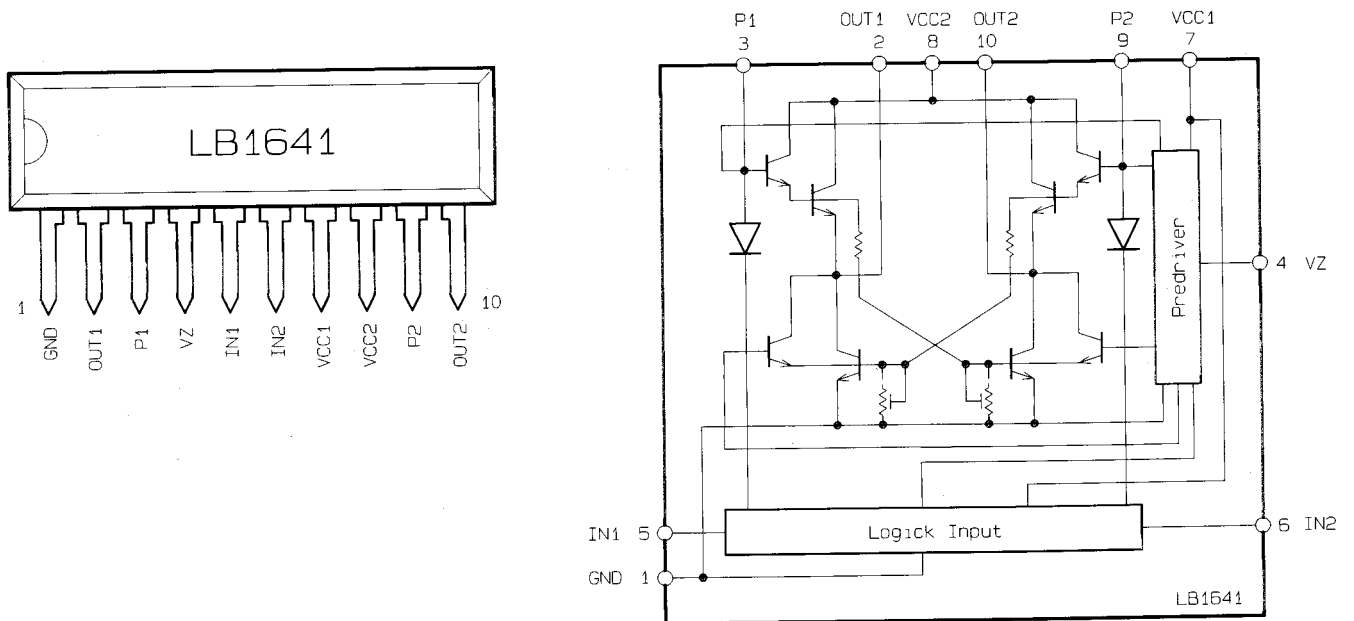

Fig. 5-5

◆ IC931 (TEA6320T) E. volume

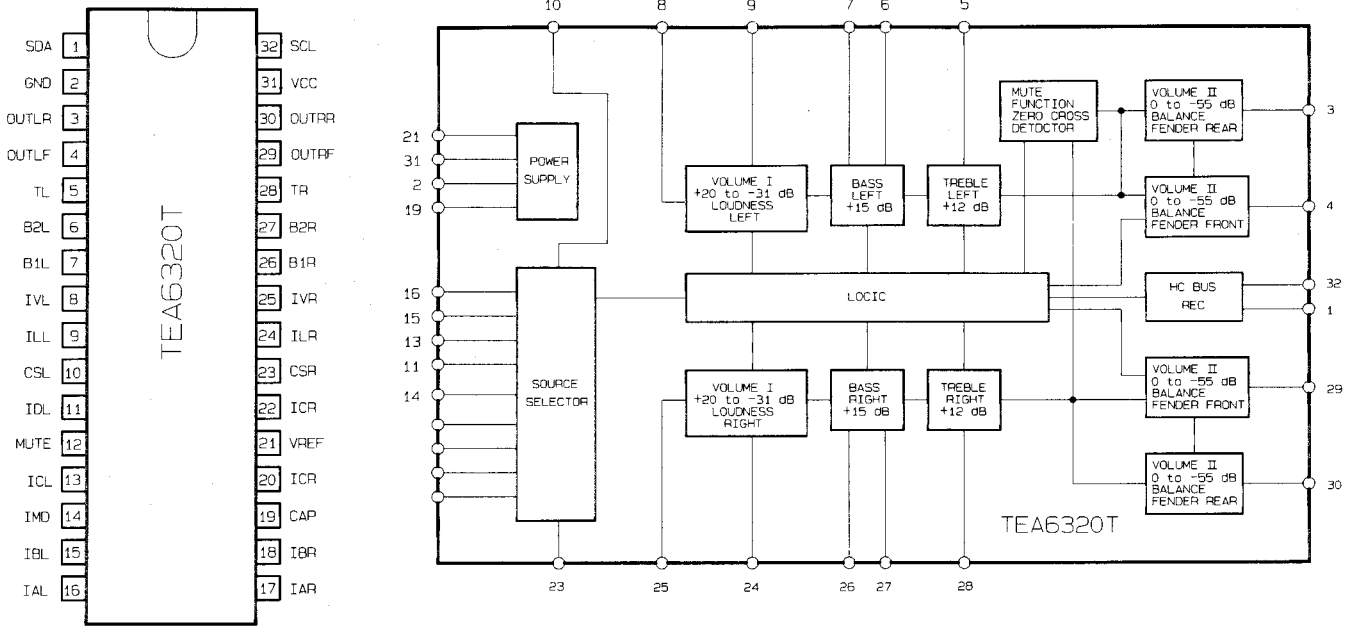

Fig. 5-6

◆ IC821 (NJM2100M)

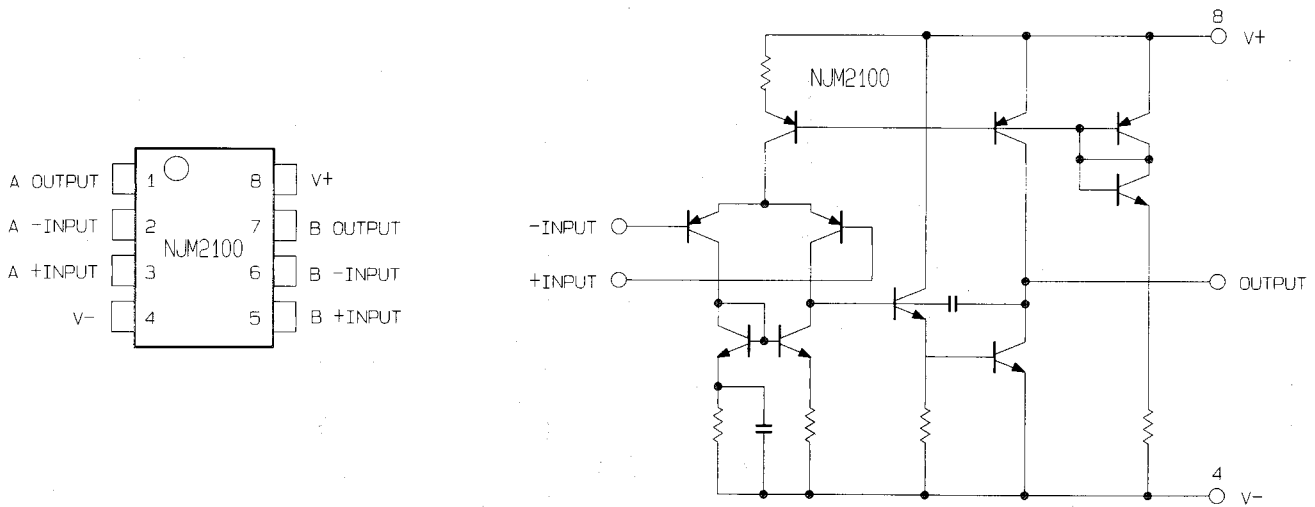

Fig. 5-7

■ Signal circuit diagram

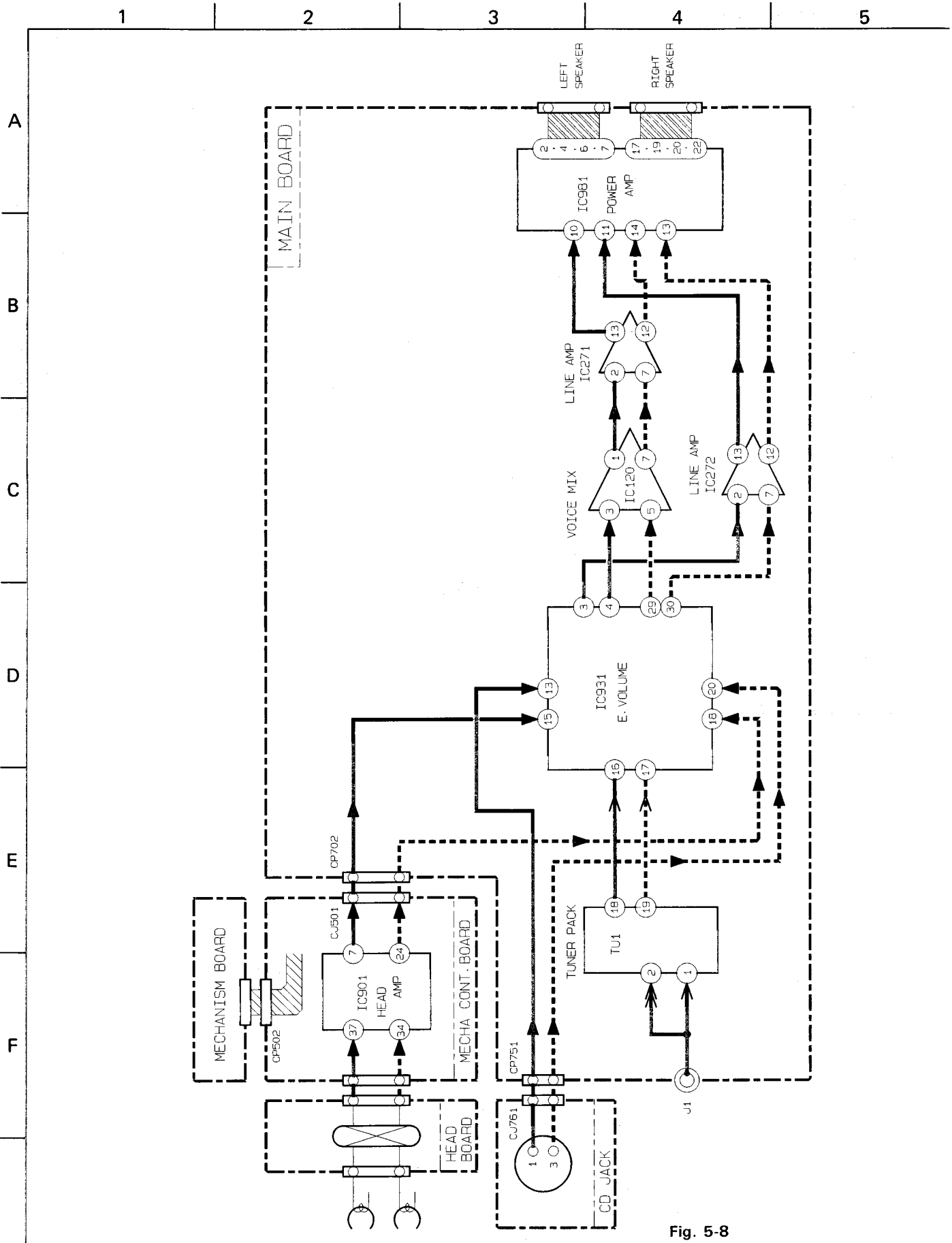

Fig. 5-8

6 Standard schematic diagram ■ Display circuit

1 2 3 4 5

A

B

C

D

E

F

Note : VDH3765001SM1/S/G1

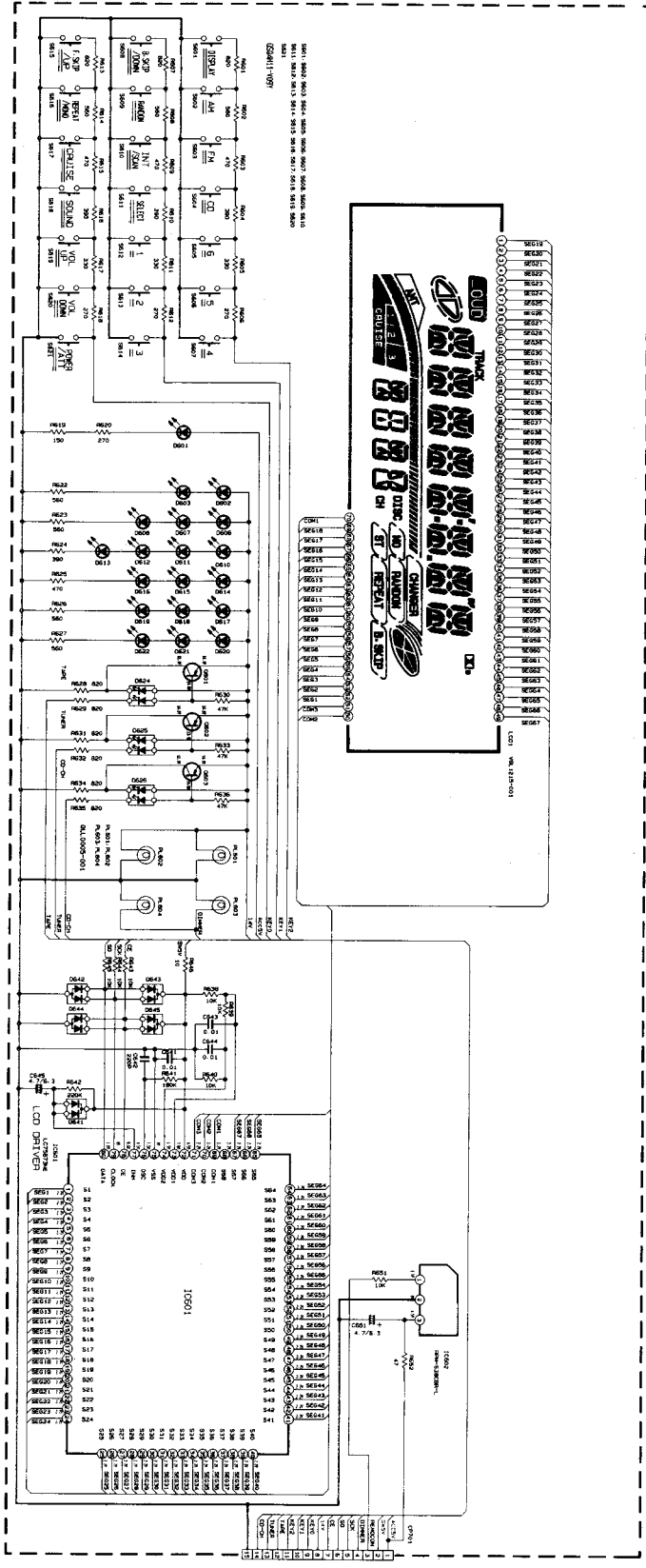

NOTES
 1. UNLESS AND OTHERWISE NOTED IN THE DRAWING, ALL METERS SHOULD BE USED IN THE FOLLOWING MANNER:
 (A) RESISTORS: ALL RESISTORS ARE IN OHMS UNLESS OTHERWISE NOTED.
 (B) CAPACITORS: ALL CAPACITORS ARE IN PICO FARADS UNLESS OTHERWISE NOTED.
 (C) ALL DIMENSIONS ARE IN MILLIMETERS UNLESS OTHERWISE NOTED.
 (D) ALL CONNECTIONS ARE TO BE MADE IN THE FORM OF CONNECTIONS SHOWN IN THE DRAWING.
 (E) ALL CONNECTIONS ARE TO BE MADE IN THE FORM OF CONNECTIONS SHOWN IN THE DRAWING.
 (F) ALL CONNECTIONS ARE TO BE MADE IN THE FORM OF CONNECTIONS SHOWN IN THE DRAWING.

25883-587-1-118	0001, 0002, 0003
4415304-1-1	0041, 0043, 0045
4415304-1-2	0042, 0044
541-0104-117	0001, 0002, 0003, 0006, 0007
	0008, 0010, 0011, 0012, 0013
	0014, 0015, 0016, 0017, 0018
	0019, 0020, 0021, 0022
541-0204-117	0024, 0025, 0026

Note VDH3765001SW

Fig. 6-1

Cassette amplifier circuit

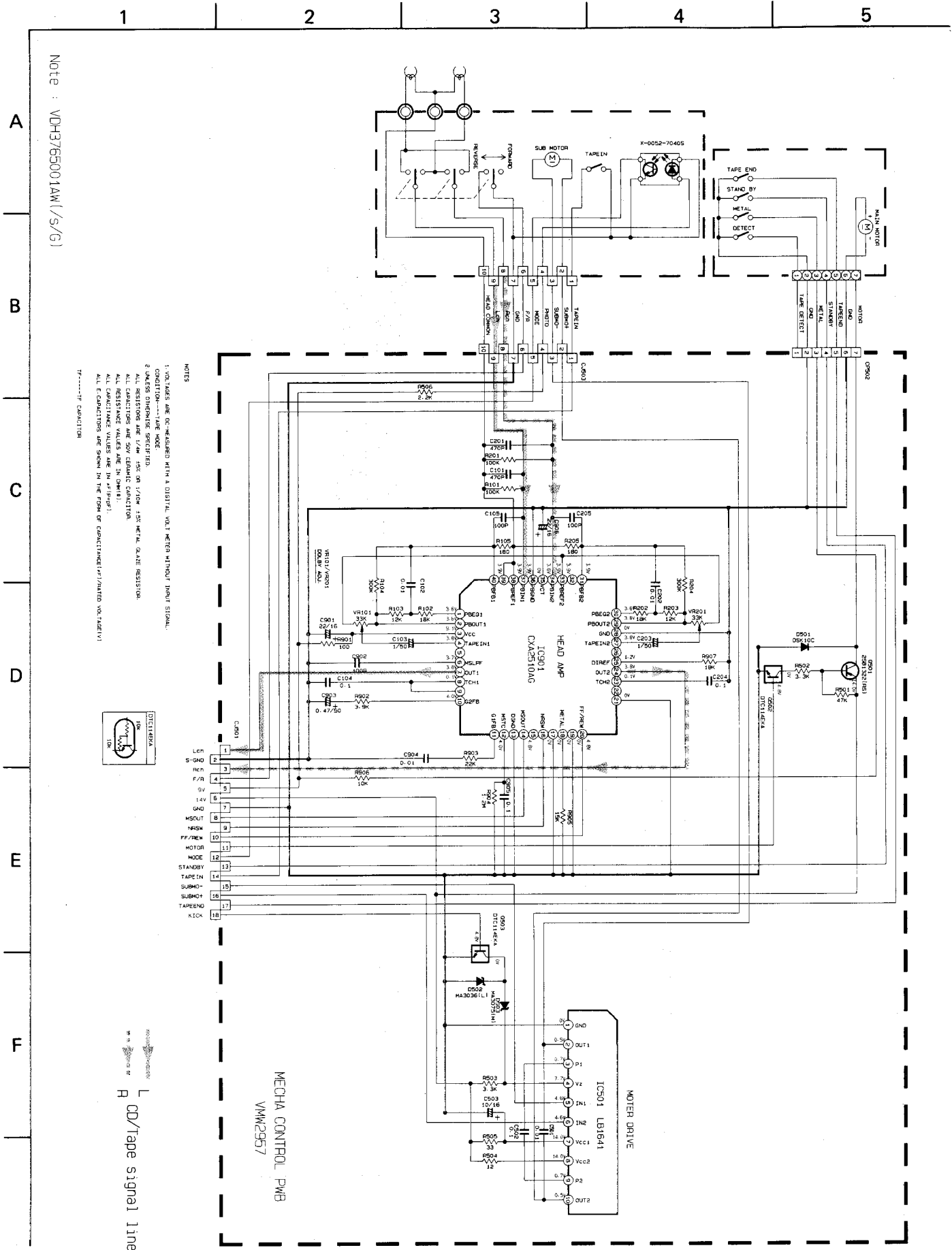

Note : VDH3785001AW (S/G)

- NOTES
1. VOLTAGES ARE DC-MEASURED WITH A DIGITAL VOLT-METER WITHOUT INPUT SIGNAL.
 2. CONDITION---TAPE MODE
 3. VALUES DIMENSIONED SPECIFIED
 4. ALL RESISTORS ARE 1/4W 10% OR 1/10W 1% METAL GLAZE RESISTOR.
 5. ALL CAPACITORS ARE 50V CERAMIC CAPACITOR.
 6. ALL RESISTOR VALUES ARE IN OHMS UNLESS OTHERWISE SPECIFIED.
 7. ALL CAPACITOR VALUES ARE IN PICO FARADS UNLESS OTHERWISE SPECIFIED.
 8. ALL RESISTORS ARE 5% TOLERANCE UNLESS OTHERWISE SPECIFIED.
 9. ALL CAPACITORS ARE 5% TOLERANCE UNLESS OTHERWISE SPECIFIED.
 10. ALL CAPACITORS ARE SHOWN IN THE FORM OF CAPACITANCE (P/F/MIN/O MAX/TAPE/VI).
 11. TF-----TF CAPACITOR



MECHA CONTROL PWB
VMM2957
CD/Tape signal line

Note
VDH3785001AW

Fig. 6-2

Tuner/amplifier circuit

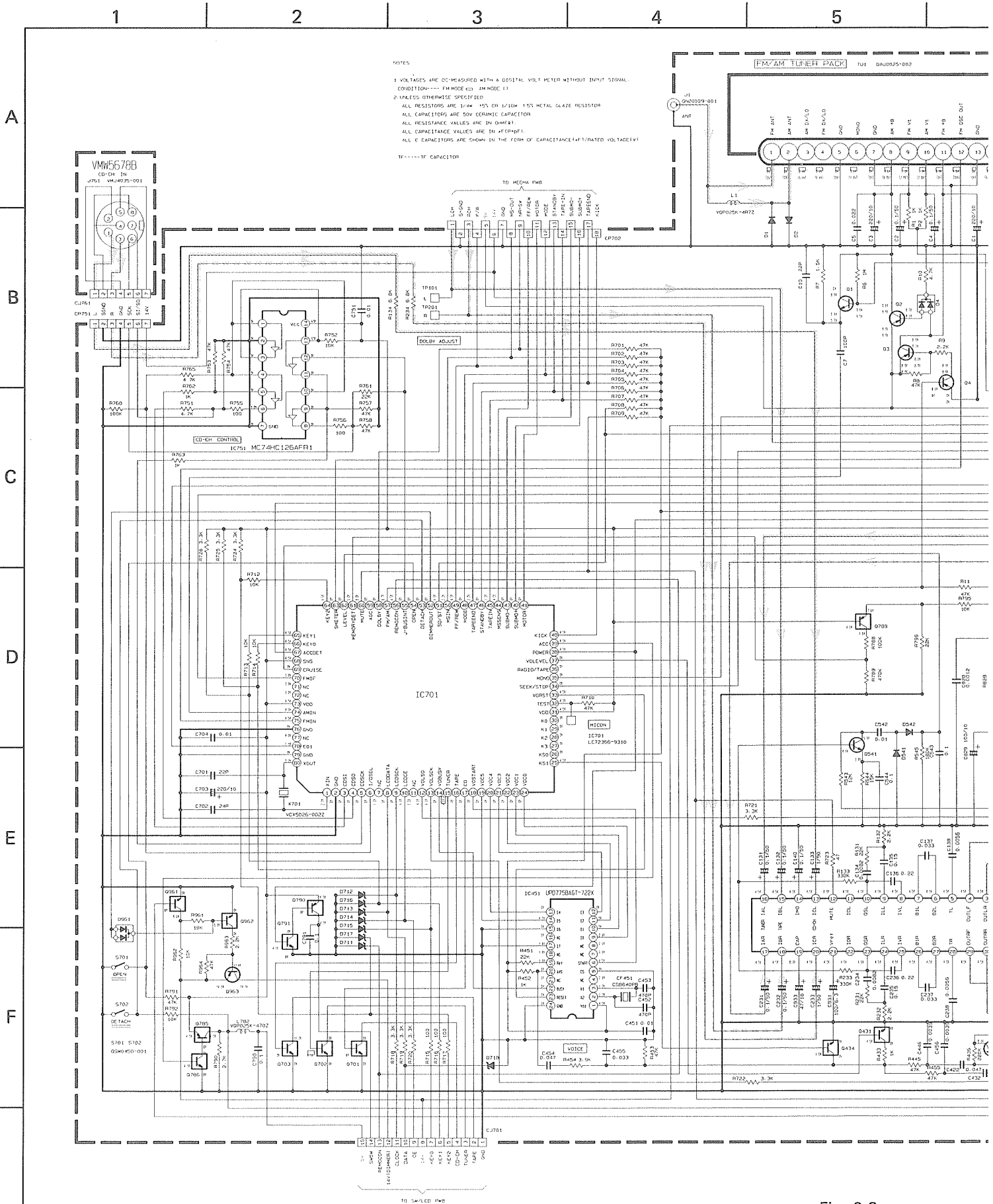

Fig. 6-3

Note : VDH3765001RV(L/S/G)

6

7

8

9

10

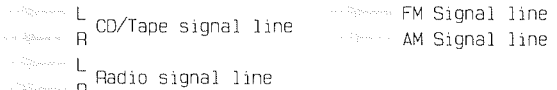
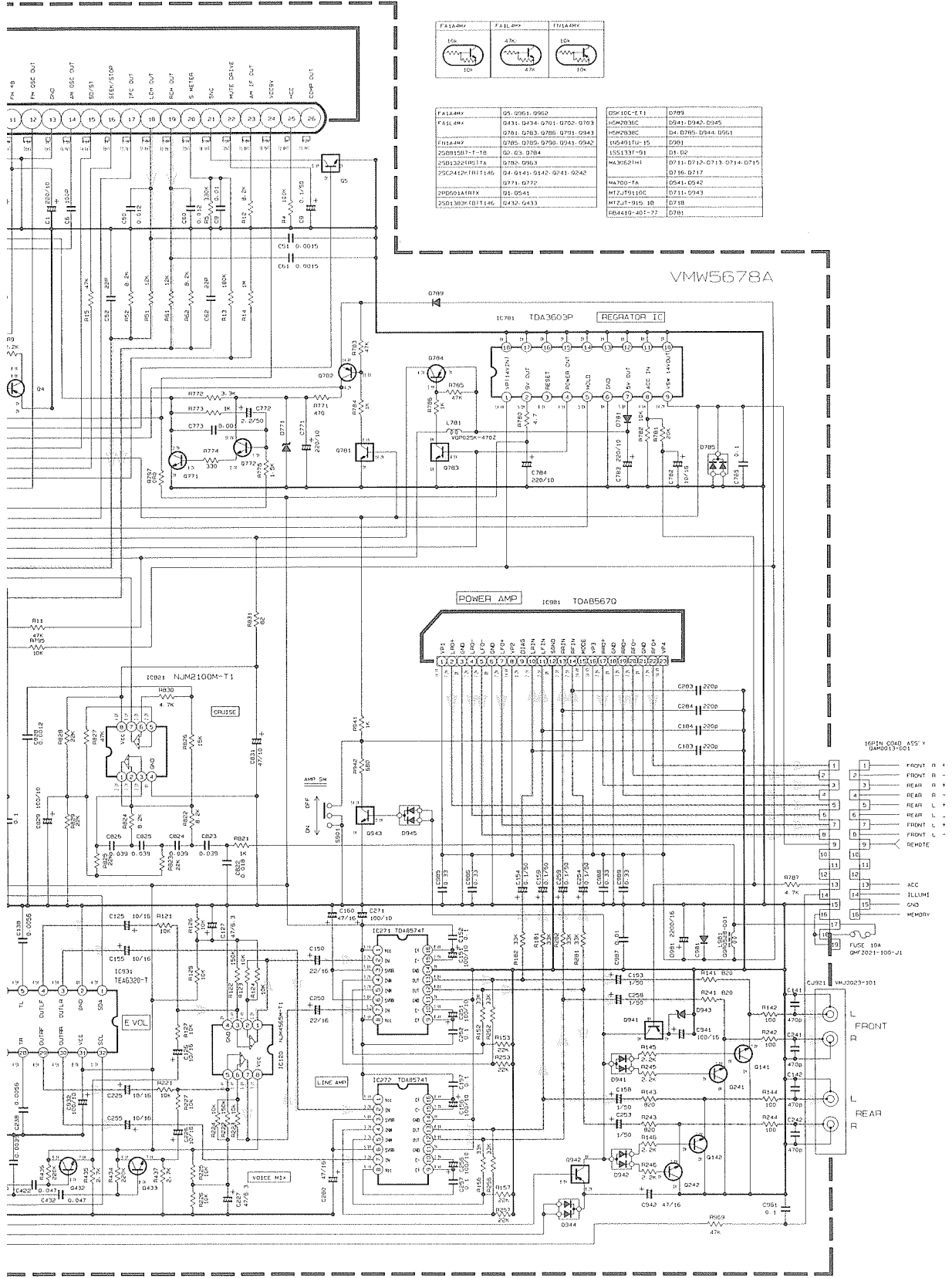

7 Location of p. c. board parts and parts list

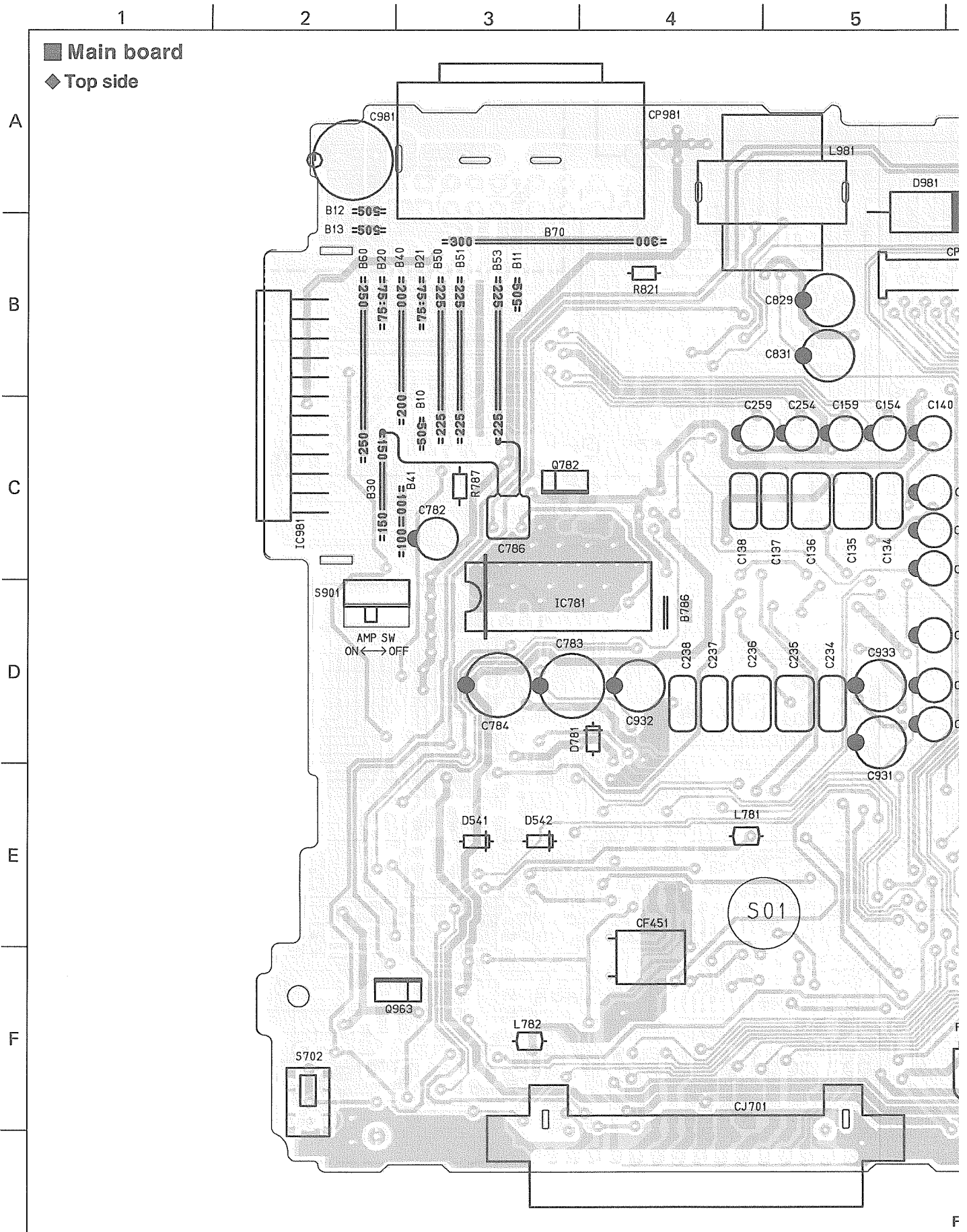

6

7

8

9

10

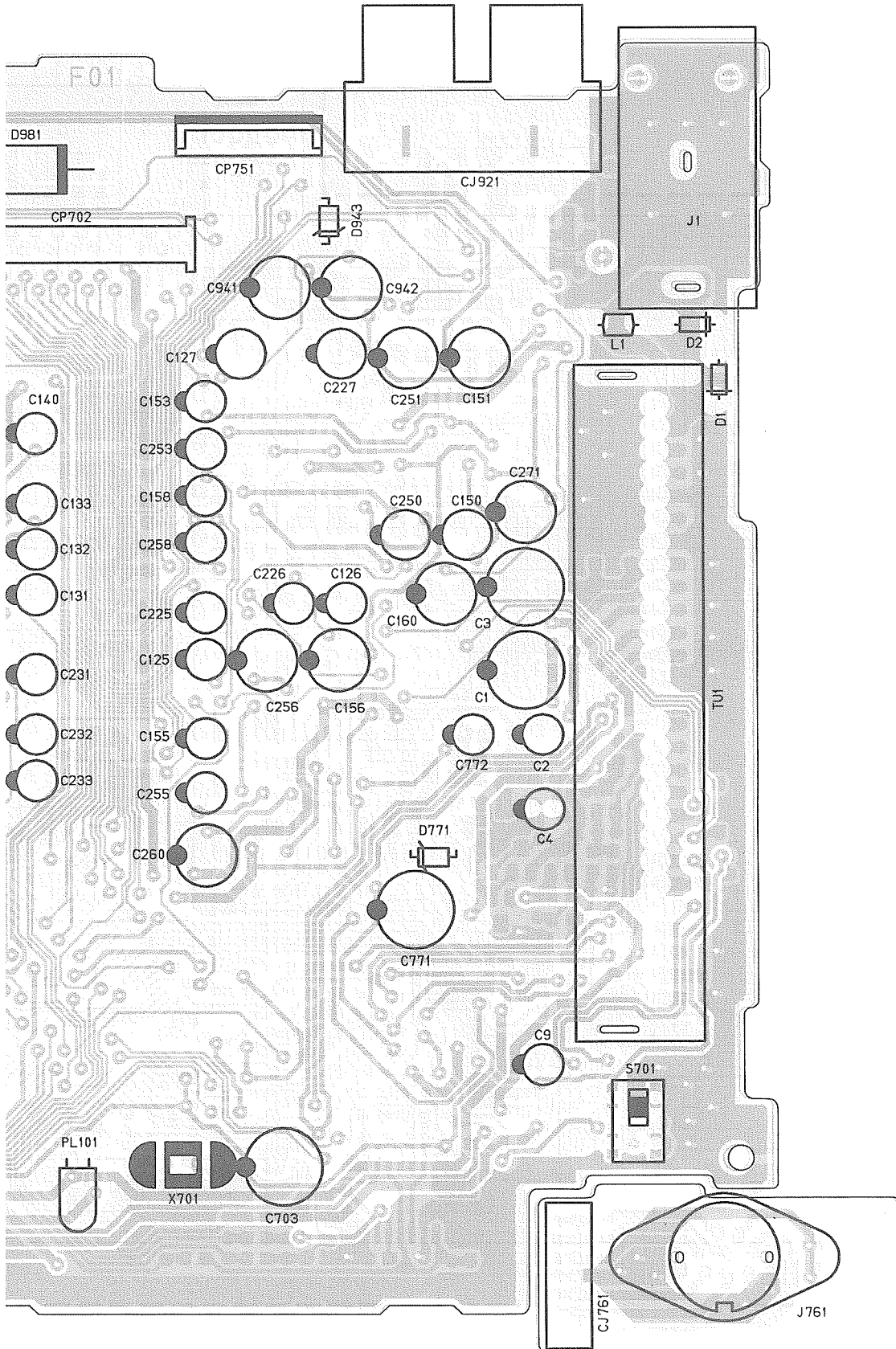

Fig. 7-1

1

2

3

4

5

◆ Bottom side

A

B

C

D

E

F

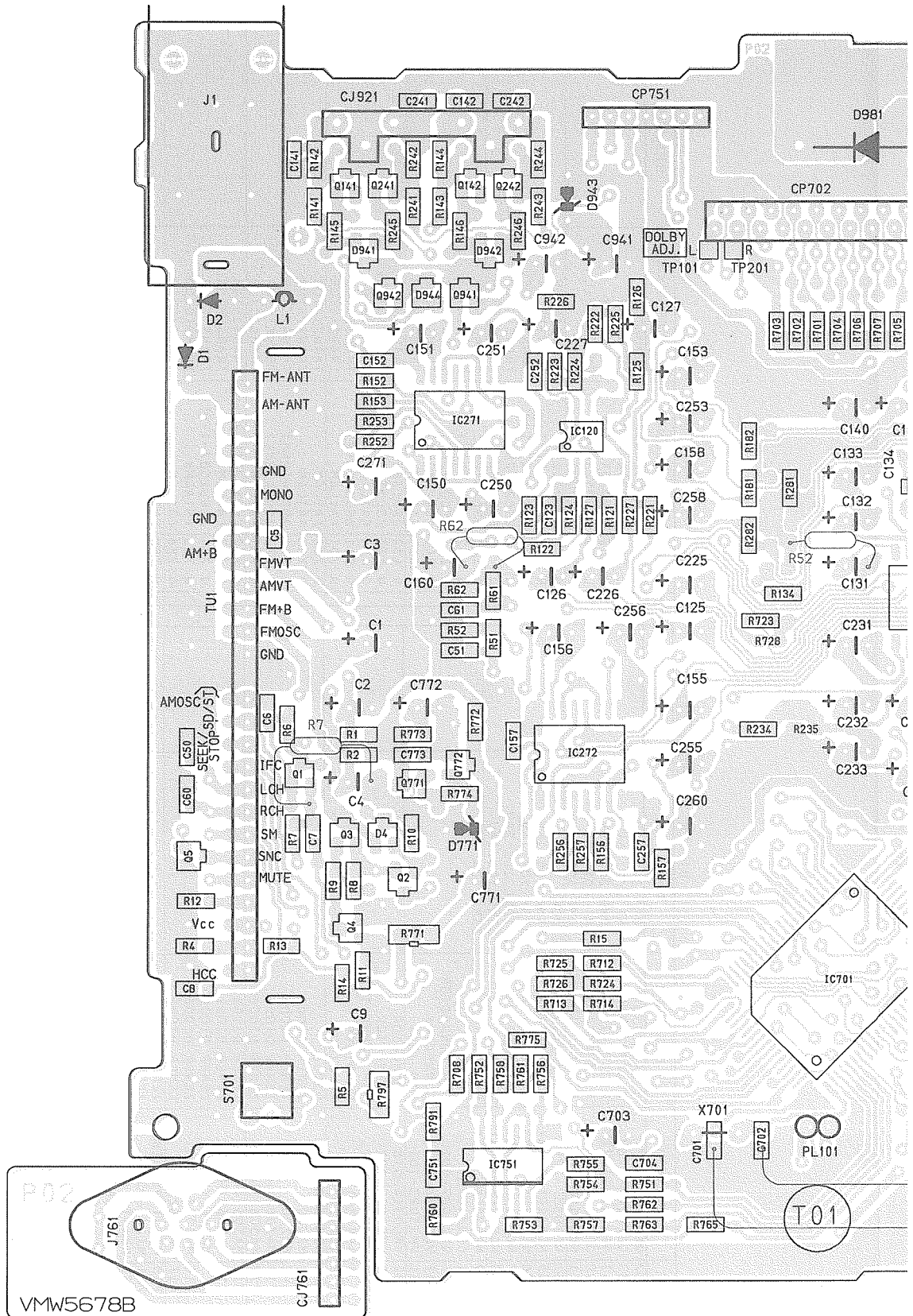

6

7

8

9

10

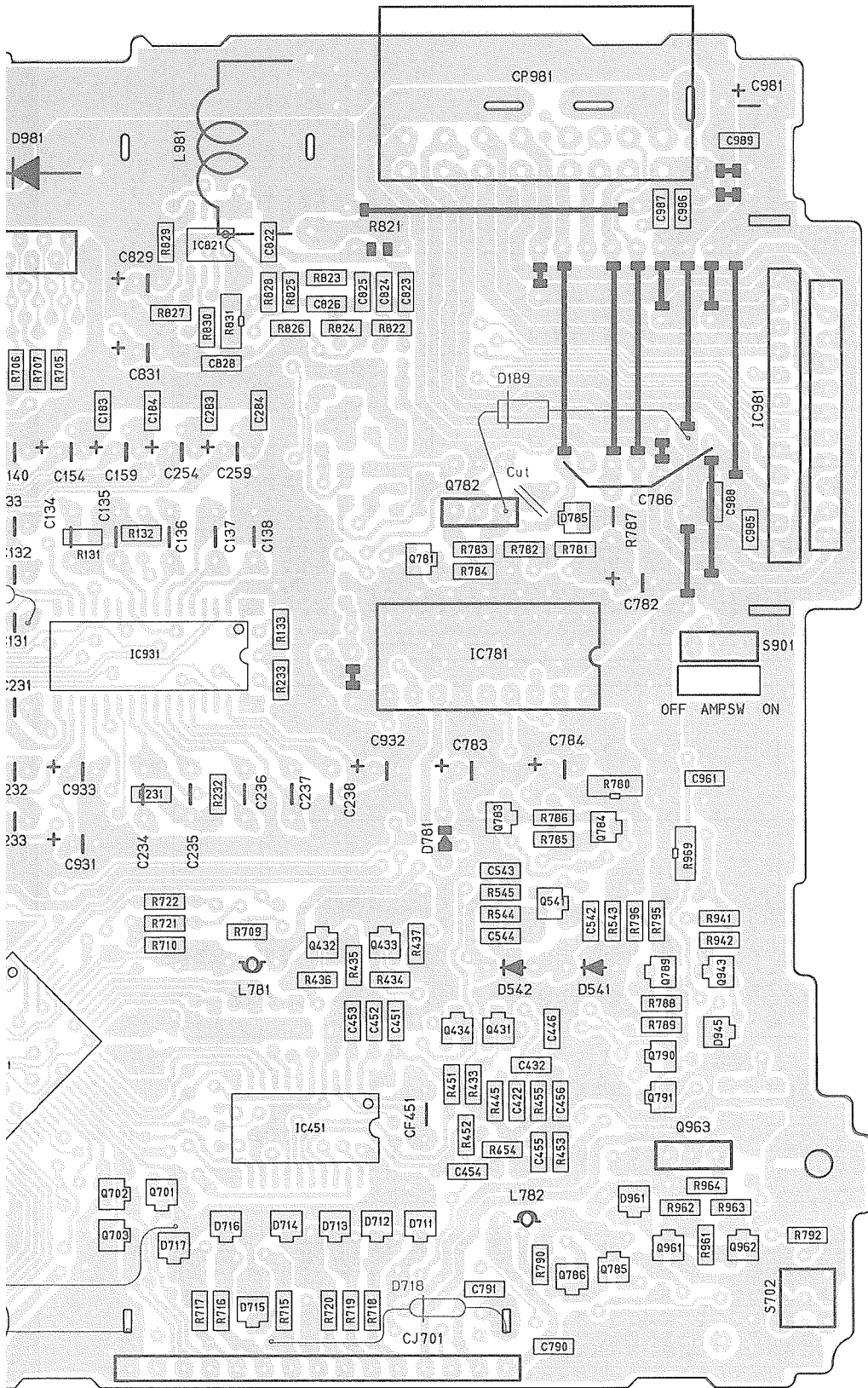

Fig. 7-2

● Main board parts list

BLOCK NO. 01111111

A	REF.	PARTS NO.	PARTS NAME	REMARKS	SUFFIX
	C 251	QER41AM-107	E. CAPACITOR	100MF 20% 10V	
	C 252	NCB21HK-104	C. CAPACITOR	-10MF 10% 25V	
	C 253	QER41HM-105VM	E. CAPACITOR	1.0MF 20% 50V	
	C 254	QERF1HM-104ZM	E. CAPACITOR	-10MF 20% 50V	
	C 255	QER41CM-106	E. CAPACITOR	10MF 20% 16V	
	C 256	QER41AM-107	E. CAPACITOR	100MF 20% 10V	
	C 257	NCB21HK-104	C. CAPACITOR	-10MF 10% 25V	
	C 258	QER41HM-105VM	E. CAPACITOR	1.0MF 20% 50V	
	C 259	QERF1HM-104ZM	E. CAPACITOR	-10MF 20% 50V	
	C 260	QER41CM-476M	E. CAPACITOR	47MF 20% 16V	
	C 271	QER41AM-107	E. CAPACITOR	100MF 20% 10V	
	C 283	NCB21HK-221AY	C. CAPACITOR	220PF 5% 50V	
	C 284	NCB21HK-221AY	C. CAPACITOR	220PF 5% 50V	
	C 422	NCB21HK-473AY	C. CAPACITOR	-0.47MF 10% 25V	
	C 432	NCB21HK-473AY	C. CAPACITOR	-0.47MF 10% 25V	
	C 445	NCB21HK-392AY	C. CAPACITOR	3900PF 10% 50V	
	C 446	NCB21HK-103AY	C. CAPACITOR	-0.10MF 10% 25V	
	C 452	NCB21HK-471AY	C. CAPACITOR	470PF 5% 50V	
	C 453	NCB21HK-471AY	C. CAPACITOR	470PF 5% 50V	
	C 454	NCB21HK-473AY	C. CAPACITOR	-0.47MF 10% 25V	
	C 455	NCB21HK-333AY	C. CAPACITOR	-0.33MF 10% 25V	
	C 456	NCB21HK-392AY	C. CAPACITOR	3900PF 10% 50V	
	C 542	NCB21HK-103AY	C. CAPACITOR	-0.10MF 10% 25V	
	C 543	NCB21HK-104	C. CAPACITOR	-10MF 10% 25V	
	C 544	NCB21HK-104	C. CAPACITOR	-10MF 10% 25V	
	C 701	NCB21HK-220AY	C. CAPACITOR	22PF +50% -10% 1	
	C 702	NCB21HK-240	C. CAPACITOR	24PF +50% -10% 1	
	C 703	QERF1AM-227Z	E. CAPACITOR	220MF 20% 10V	
	C 704	NCB21HK-103AY	C. CAPACITOR	-0.10MF 10% 50V	
	C 711	NCB21HK-104	C. CAPACITOR	-10MF 10% 25V	
	C 712	NCB21HK-104	C. CAPACITOR	-10MF 10% 25V	
	C 713	NCB21HK-104	C. CAPACITOR	-10MF 10% 25V	
	C 751	NCB21HK-103AY	C. CAPACITOR	-0.10MF 10% 50V	
	C 771	QERF1AM-227Z	E. CAPACITOR	220MF 20% 10V	
	C 772	QER41HM-225	E. CAPACITOR	2.2MF 20% 50V	
	C 773	NCB21HK-103AY	C. CAPACITOR	1000PF 10% 50V	
	C 782	QER41CM-106	E. CAPACITOR	10MF 20% 16V	
	C 783	QERF1AM-227Z	E. CAPACITOR	220MF 20% 10V	
	C 784	QERF1AM-227Z	E. CAPACITOR	220MF 20% 10V	
	C 786	NCB21HK-104	C. CAPACITOR	-10MF 10% 25V	
	C 790	NCB21HK-104	C. CAPACITOR	-10MF 10% 25V	
	C 791	NCB21HK-104	C. CAPACITOR	-10MF 10% 25V	
	C 795	NCB21HK-104	C. CAPACITOR	-10MF 10% 25V	
	C 796	NCB21HK-104	C. CAPACITOR	-10MF 10% 25V	
	C 797	QERF1CM-107ZM	E. CAPACITOR	100MF 20% 15V	
	C 798	QERF1AM-227Z	E. CAPACITOR	220MF 20% 10V	
	C 822	NCB21HK-183AY	C. CAPACITOR	-0.18MF 10% 50V	
	C 823	NCB21HK-393AY	C. CAPACITOR	-0.39MF 10% 25V	
	C 824	NCB21HK-393AY	C. CAPACITOR	-0.39MF 10% 25V	
	C 825	NCB21HK-393AY	C. CAPACITOR	-0.39MF 10% 25V	
	C 826	NCB21HK-393AY	C. CAPACITOR	-0.39MF 10% 25V	
	C 828	NCB21HK-122AY	C. CAPACITOR	1200PF 10% 50V	
	C 829	QER41AM-107	E. CAPACITOR	100MF 20% 10V	
	C 831	QERF1AM-476Z	E. CAPACITOR	47MF 20% 10V	
	C 931	QER40JN-107	E. CAPACITOR	100MF 20% 6.3V	

BLOCK NO. 01111111

A	REF.	PARTS NO.	PARTS NAME	REMARKS	SUFFIX
	C 1	QERF1AM-227Z	E. CAPACITOR	220MF 20% 10V	
	C 2	QERF1HM-104ZM	E. CAPACITOR	-10MF 20% 50V	
	C 3	QERF1AM-227Z	E. CAPACITOR	220MF 20% 10V	
	C 4	QERF1HM-104ZM	E. CAPACITOR	-10MF 20% 50V	
	C 5	NCB21HK-223AY	C. CAPACITOR	-0.22MF 10% 50V	
	C 6	NCB21HK-101AY	C. CAPACITOR	100PF +50% -10%	
	C 7	NCB21HK-101AY	C. CAPACITOR	100PF +50% -10%	
	C 8	NCB21HK-103AY	C. CAPACITOR	-0.10MF 10% 25V	
	C 9	QERF1HM-104ZM	E. CAPACITOR	-10MF 20% 50V	
	C 10	NCB21HK-220AY	C. CAPACITOR	22PF +50% -10% 1	
	C 50	NCB21HK-123AY	C. CAPACITOR	-0.12MF 10% 25V	
	C 52	NCB21HK-220AY	C. CAPACITOR	22PF +50% -10% 1	
	C 60	NCB21HK-123AY	C. CAPACITOR	-0.12MF 10% 25V	
	C 62	NCB21HK-220AY	C. CAPACITOR	22PF +50% -10% 1	
	C 123	QER41CM-106	E. CAPACITOR	10MF 20% 16V	
	C 126	QER41CM-106	E. CAPACITOR	10MF 20% 16V	
	C 127	QERF1HM-476ZN	E. CAPACITOR	47MF 20% 6.3V	
	C 131	QERF1HM-104ZM	E. CAPACITOR	-10MF 20% 50V	
	C 132	QERF1HM-104ZM	E. CAPACITOR	-10MF 20% 50V	
	C 133	QERF1HM-105VM	E. CAPACITOR	1.0MF 20% 50V	
	C 134	QFLA1HJ-822ZM	M. CAPACITOR	8200PF 5% 50V	
	C 135	QFV1HJ-1544ZM	FILM CAPACITOR	-1.5MF 5% 50V	
	C 136	QFV1HJ-224	FILM CAPACITOR	-2.2MF 5% 50V	
	C 137	QFV1HJ-333	FILM CAPACITOR	-0.33MF 5% 50V	
	C 138	QFLA1HJ-562ZM	M. CAPACITOR	5600PF 5% 50V	
	C 140	QERF1HM-104ZM	E. CAPACITOR	-10MF 20% 50V	
	C 141	NCB21HK-471AY	C. CAPACITOR	470PF 10% 50V	
	C 142	NCB21HK-471AY	C. CAPACITOR	470PF 10% 50V	
	C 150	QER41CM-226VM	E. CAPACITOR	22MF 20% 16V	
	C 151	QER41AM-107	E. CAPACITOR	100MF 20% 10V	
	C 152	NCB21HK-104	C. CAPACITOR	-10MF 10% 25V	
	C 153	QER41HM-105VM	E. CAPACITOR	1.0MF 20% 50V	
	C 154	QERF1HM-104ZM	E. CAPACITOR	-10MF 20% 50V	
	C 155	QER41CM-106	E. CAPACITOR	10MF 20% 16V	
	C 156	QER41AM-107	E. CAPACITOR	100MF 20% 10V	
	C 157	NCB21HK-104	C. CAPACITOR	-10MF 10% 25V	
	C 158	QER41HM-105VM	E. CAPACITOR	1.0MF 20% 50V	
	C 159	QERF1HM-104ZM	E. CAPACITOR	-10MF 20% 50V	
	C 160	QER41CM-476M	E. CAPACITOR	47MF 20% 16V	
	C 183	NCB21HK-221AY	C. CAPACITOR	220PF 5% 50V	
	C 184	NCB21HK-221AY	C. CAPACITOR	220PF 5% 50V	
	C 225	QER41CM-106	E. CAPACITOR	10MF 20% 16V	
	C 226	QER41CM-106	E. CAPACITOR	10MF 20% 16V	
	C 227	QERF1HM-476ZN	E. CAPACITOR	47MF 20% 6.3V	
	C 231	QERF1HM-104ZM	E. CAPACITOR	-10MF 20% 50V	
	C 232	QERF1HM-104ZM	E. CAPACITOR	-10MF 20% 50V	
	C 233	QER41HM-105VM	E. CAPACITOR	1.0MF 20% 50V	
	C 234	QFLA1HJ-822ZM	M. CAPACITOR	8200PF 5% 50V	
	C 235	QFV1HJ-1544ZM	FILM CAPACITOR	-1.5MF 5% 50V	
	C 236	QFV1HJ-224	FILM CAPACITOR	-2.2MF 5% 50V	
	C 237	QFV1HJ-333	FILM CAPACITOR	-0.33MF 5% 50V	
	C 238	QFLA1HJ-562ZM	M. CAPACITOR	5600PF 5% 50V	
	C 241	NCB21HK-471AY	C. CAPACITOR	470PF 10% 50V	
	C 242	NCB21HK-471AY	C. CAPACITOR	470PF 10% 50V	
	C 250	QER41CM-226VM	E. CAPACITOR	22MF 20% 16V	

BLOCK NO. 01111111

REF.	PARTS NO.	PARTS NAME	REMARKS	SUFFIX
L 1	VQP025K-4R7Y	INDUCTOR		
L 781	VQP025K-470Y	INDUCTOR		
L 782	VQP025K-470Y	INDUCTOR		
L 981	QOR0528-001	CHOKE COIL		
PL101	VGZ0001-042	LAMP		
Q 1	25C2412KK1	TRANSISTOR		
Q 2	25B815B7-T-HL	TRANSISTOR		
Q 3	25B815B7-T-HL	TRANSISTOR		
Q 4	25C2412KK1	TRANSISTOR		
Q 5	FA1A4M	TRANSISTOR		
Q 141	25C2412KK1	TRANSISTOR		
Q 142	25C2412KK1	TRANSISTOR		
Q 241	25C2412KK1	TRANSISTOR		
Q 242	25C2412KK1	TRANSISTOR		
Q 431	FA1L4M	TRANSISTOR		
Q 432	25D1383K(B)T146	TRANSISTOR		
Q 433	25D1383K(B)T146	TRANSISTOR		
Q 434	FA1L4M	TRANSISTOR		
Q 541	2SD601A(R)	TRANSISTOR		
Q 701	FA1L4M	TRANSISTOR		
Q 702	FA1L4M	TRANSISTOR		
Q 703	FA1L4M	TRANSISTOR		
Q 771	25C2412KK1	TRANSISTOR		
Q 772	25C2412KK1	TRANSISTOR		
Q 781	FA1L4M	TRANSISTOR		
Q 782	25B1322(RS)	TRANSISTOR		
Q 783	FA1L4M	TRANSISTOR		
Q 784	25B815B7-T-HL	TRANSISTOR		
Q 785	FM1A4MX	TRANSISTOR		
Q 786	FA1L4M	TRANSISTOR		
Q 789	FM1A4MX	TRANSISTOR		
Q 790	FM1A4MX	TRANSISTOR		
Q 791	FA1L4M	TRANSISTOR		
Q 941	FM1A4MX	TRANSISTOR		
Q 942	FM1A4MX	TRANSISTOR		
Q 943	FA1L4M	TRANSISTOR		
Q 961	FA1A4M	TRANSISTOR		
Q 962	FA1A4M	TRANSISTOR		
Q 963	25B1322(RS)	TRANSISTOR		
R 1	NRSA02J-102NY	MG RESISTOR	1.0K 5% 1/10W	
R 2	NRSA02J-102NY	MG RESISTOR	1.0K 5% 1/10W	
R 4	NRSA02J-104NY	MG RESISTOR	100K 5% 1/10W	
R 5	NRSA02J-334NY	MG RESISTOR	330K 5% 1/10W	
R 6	NRSA02J-105NY	MG RESISTOR	1.0M 5% 1/10W	
R 7	NRSA02J-152NY	MG RESISTOR	1.5K 5% 1/10W	
R 8	NRSA02J-475NY	MG RESISTOR	47K 5% 1/10W	
R 9	NRSA02J-222NY	MG RESISTOR	2.2K 5% 1/10W	
R 10	NRSA02J-472NY	MG RESISTOR	4.7K 5% 1/10W	
R 11	NRSA02J-475NY	MG RESISTOR	47K 5% 1/10W	
R 12	NRSA02J-822NY	MG RESISTOR	8.2K 5% 1/10W	
R 13	NRSA02J-184NY	MG RESISTOR	180K 5% 1/10W	
R 14	NRSA02J-105NY	MG RESISTOR	1.0M 5% 1/10W	
R 15	NRSA02J-475NY	MG RESISTOR	47K 5% 1/10W	
R 51	NRSA02J-123NY	MG RESISTOR	12K 5% 1/10W	
R 52	NRSA02J-822NY	MG RESISTOR	8.2K 5% 1/10W	

BLOCK NO. 01111111

REF.	PARTS NO.	PARTS NAME	REMARKS	SUFFIX
C 922	QER41M-107	E-CAPACITOR	100MF 20% 10V	
C 933	QER41CM-476M	E-CAPACITOR	47MF 20% 16V	
C 941	QERF1CM-107ZM	E-CAPACITOR	100MF 20% 16V	
C 942	QER41CM-476M	E-CAPACITOR	47MF 20% 16V	
C 961	NCB21HK-104	C. CAPACITOR	.10MF 10% 25V	
C 981	QEZ0337-228	E CAPACITOR	2200MF	
C 985	NCB21CK-334AY	C CAPACITOR	.33MF 10% 16V	
C 986	NCB21CK-334AY	C CAPACITOR	.33MF 10% 16V	
C 987	NCB21HK-103AY	C CAPACITOR	.010MF 10% 25V	
C 988	NCB21CK-334AY	C CAPACITOR	.33MF 10% 16V	
C 989	NCB21CK-334AY	C CAPACITOR	.33MF 10% 16V	
CF451	CSB640PB	CERA LOCK		
CJ701	QNZ0007-001	CAR CONNECTOR		
CJ761	VMCO136-007	CONNECTOR		
CJ921	VMJ3023-101	PIN JACK		
CP702	VMCO314-S18	CONNECTOR		
CP751	VMCO135-007	CONNECTOR		
CP981	QNZ0002-001	16P CONNECTOR		
D 1	1SS133T-91	SI DIODE		
D 2	1SS133T-91	SI DIODE		
D 4	HSM2838C	DIODE		
D 541	MA700	ZENER DIODE		
D 542	MA700	ZENER DIODE		
D 711	MA3062(H)	ZENER DIODE		
D 712	MA3062(H)	ZENER DIODE		
D 713	MA3062(H)	ZENER DIODE		
D 714	MA3062(H)	ZENER DIODE		
D 715	MA3062(H)	ZENER DIODE		
D 716	MA3062(H)	ZENER DIODE		
D 717	MA3062(H)	ZENER DIODE		
D 718	MTZJT-915.1B	ZENER DIODE		
D 771	MTZJT-9110C	ZENER DIODE		
D 781	R8441Q-40T-77	S.B. DIODE		
D 785	HSM2838C	DIODE		
D 786	DSK10C-E	DIODE		
D 941	HSM2836C	DIODE		
D 942	HSM2836C	DIODE		
D 943	MTZJT-9111C	ZENER DIODE		
D 944	HSM2838C	DIODE		
D 945	HSM2838C	DIODE		
D 961	HSM2838C	DIODE		
D 981	1N5401TU-15	DIODE		
IC120	NJM4565M	IC		
IC271	TDA8574T-T	IC		
IC272	TDA8574T-T	IC		
IC451	HPD758AGT-722X	IC		
IC701	LC72366-9315	IC		
IC751	HD74HC126FP-EL	IC		
IC781	TDA3603P-S	IC		
IC782	UPC78M12AHF	IC		
IC821	NJM2100M	IC		
IC931	TEA6320T	IC		
IC981	TDA8567Q	IC		
J 1	QNZ0009-001	CAR ANT JACK		
J 761	VMJ4035-001	MINI DIN JACK		

BLOCK NO. 01111111

A	REF.	PARTS NO.	PARTS NAME	REMARKS	SUFFIX
	R 451	NRSA02J-223NY	MG RESISTOR	22K 5% 1/10W	
	R 452	NRSA02J-102NY	MG RESISTOR	1.0K 5% 1/10W	
	R 453	NRSA02J-473NY	MG RESISTOR	47K 5% 1/10W	
	R 454	NRSA02J-392NY	MG RESISTOR	3.9K 5% 1/10W	
	R 455	NRSA02J-473NY	MG RESISTOR	47K 5% 1/10W	
	R 543	NRSA02J-123NY	MG RESISTOR	12K 5% 1/10W	
	R 544	NRSA02J-153NY	MG RESISTOR	15K 5% 1/10W	
	R 545	NRSA02J-184NY	MG RESISTOR	180K 5% 1/10W	
	R 701	NRSA02J-473NY	MG RESISTOR	47K 5% 1/10W	
	R 702	NRSA02J-473NY	MG RESISTOR	47K 5% 1/10W	
	R 703	NRSA02J-473NY	MG RESISTOR	47K 5% 1/10W	
	R 704	NRSA02J-473NY	MG RESISTOR	47K 5% 1/10W	
	R 705	NRSA02J-473NY	MG RESISTOR	47K 5% 1/10W	
	R 706	NRSA02J-473NY	MG RESISTOR	47K 5% 1/10W	
	R 707	NRSA02J-473NY	MG RESISTOR	47K 5% 1/10W	
	R 708	NRSA02J-473NY	MG RESISTOR	47K 5% 1/10W	
	R 709	NRSA02J-473NY	MG RESISTOR	47K 5% 1/10W	
	R 710	NRSA02J-473NY	MG RESISTOR	47K 5% 1/10W	
	R 711	NRSA02J-103NY	MG RESISTOR	10K 5% 1/10W	
	R 712	NRSA02J-103NY	MG RESISTOR	10K 5% 1/10W	
	R 713	NRSA02J-103NY	MG RESISTOR	10K 5% 1/10W	
	R 714	NRSA02J-103NY	MG RESISTOR	10K 5% 1/10W	
	R 715	NRSA02J-101NY	MG RESISTOR	100 5% 1/10W	
	R 716	NRSA02J-101NY	MG RESISTOR	100 5% 1/10W	
	R 717	NRSA02J-101NY	MG RESISTOR	100 5% 1/10W	
	R 718	NRSA02J-332NY	MG RESISTOR	3.3K 5% 1/10W	
	R 719	NRSA02J-332NY	MG RESISTOR	3.3K 5% 1/10W	
	R 720	NRSA02J-332NY	MG RESISTOR	3.3K 5% 1/10W	
	R 721	NRSA02J-332NY	MG RESISTOR	3.3K 5% 1/10W	
	R 722	NRSA02J-332NY	MG RESISTOR	3.3K 5% 1/10W	
	R 723	NRSA02J-470NY	MG RESISTOR	47 5% 1/10W	
	R 724	NRSA02J-352NY	MG RESISTOR	3.5K 5% 1/10W	
	R 725	NRSA02J-332NY	MG RESISTOR	3.3K 5% 1/10W	
	R 726	NRSA02J-332NY	MG RESISTOR	3.3K 5% 1/10W	
	R 751	NRSA02J-472NY	MG RESISTOR	4.7K 5% 1/10W	
	R 752	NRSA02J-103NY	MG RESISTOR	10K 5% 1/10W	
	R 753	NRSA02J-473NY	MG RESISTOR	47K 5% 1/10W	
	R 754	NRSA02J-473NY	MG RESISTOR	47K 5% 1/10W	
	R 755	NRSA02J-101NY	MG RESISTOR	100 5% 1/10W	
	R 756	NRSA02J-101NY	MG RESISTOR	100 5% 1/10W	
	R 757	NRSA02J-473NY	MG RESISTOR	47K 5% 1/10W	
	R 758	NRSA02J-473NY	MG RESISTOR	47K 5% 1/10W	
	R 760	NRSA02J-104NY	MG RESISTOR	100K 5% 1/10W	
	R 761	NRSA02J-223NY	MG RESISTOR	22K 5% 1/10W	
	R 762	NRSA02J-102NY	MG RESISTOR	1.0K 5% 1/10W	
	R 763	NRSA02J-102NY	MG RESISTOR	1.0K 5% 1/10W	
	R 765	NRSA02J-473NY	MG RESISTOR	4.7K 5% 1/10W	
	R 771	NRS181J-471NY	MG RESISTOR	470 5% 1/8W	
	R 772	NRSA02J-332NY	MG RESISTOR	3.3K 5% 1/10W	
	R 773	NRSA02J-102NY	MG RESISTOR	1.0K 5% 1/10W	
	R 774	NRSA02J-331NY	MG RESISTOR	330 5% 1/10W	
	R 775	NRSA02J-152NY	MG RESISTOR	1.5K 5% 1/10W	
	R 780	NRS181J-4R7NY	MG RESISTOR	4.7 5% 1/8W	
	R 781	NRSA02J-203NY	MG RESISTOR	20K 5% 1/10W	
	R 782	NRSA02J-103NY	MG RESISTOR	10K 5% 1/10W	
	R 783	NRSA02J-473NY	MG RESISTOR	47K 5% 1/10W	

BLOCK NO. 01111111

A	REF.	PARTS NO.	PARTS NAME	REMARKS	SUFFIX
	R 61	NRSA02J-123NY	MG RESISTOR	12K 5% 1/10W	
	R 62	NRSA02J-822NY	MG RESISTOR	8.2K 5% 1/10W	
	R 121	NRSA02J-103NY	MG RESISTOR	10K 5% 1/10W	
	R 122	NRSA02J-154NY	MG RESISTOR	150K 5% 1/10W	
	R 123	NRSA02J-103NY	MG RESISTOR	10K 5% 1/10W	
	R 124	NRSA02J-103NY	MG RESISTOR	10K 5% 1/10W	
	R 125	NRSA02J-103NY	MG RESISTOR	10K 5% 1/10W	
	R 126	NRSA02J-103NY	MG RESISTOR	10K 5% 1/10W	
	R 127	NRSA02J-103NY	MG RESISTOR	10K 5% 1/10W	
	R 131	NRSA02J-223NY	MG RESISTOR	22K 5% 1/10W	
	R 132	NRSA02J-222NY	MG RESISTOR	2.2K 5% 1/10W	
	R 133	NRSA02J-354NY	MG RESISTOR	350K 5% 1/10W	
	R 134	NRSA02J-682NY	MG RESISTOR	6.8K 5% 1/10W	
	R 141	NRSA02J-821NY	MG RESISTOR	820 5% 1/10W	
	R 142	NRSA02J-101NY	MG RESISTOR	100 5% 1/10W	
	R 143	NRSA02J-821NY	MG RESISTOR	820 5% 1/10W	
	R 144	NRSA02J-101NY	MG RESISTOR	100 5% 1/10W	
	R 145	NRSA02J-222NY	MG RESISTOR	2.2K 5% 1/10W	
	R 146	NRSA02J-222NY	MG RESISTOR	2.2K 5% 1/10W	
	R 152	NRSA02J-333NY	MG RESISTOR	33K 5% 1/10W	
	R 153	NRSA02J-223NY	MG RESISTOR	22K 5% 1/10W	
	R 156	NRSA02J-333NY	MG RESISTOR	33K 5% 1/10W	
	R 157	NRSA02J-223NY	MG RESISTOR	22K 5% 1/10W	
	R 181	NRSA02J-333NY	MG RESISTOR	33K 5% 1/10W	
	R 182	NRSA02J-333NY	MG RESISTOR	33K 5% 1/10W	
	R 221	NRSA02J-103NY	MG RESISTOR	10K 5% 1/10W	
	R 222	NRSA02J-154NY	MG RESISTOR	150K 5% 1/10W	
	R 223	NRSA02J-103NY	MG RESISTOR	10K 5% 1/10W	
	R 224	NRSA02J-103NY	MG RESISTOR	10K 5% 1/10W	
	R 225	NRSA02J-103NY	MG RESISTOR	10K 5% 1/10W	
	R 226	NRSA02J-103NY	MG RESISTOR	10K 5% 1/10W	
	R 227	NRSA02J-103NY	MG RESISTOR	10K 5% 1/10W	
	R 231	NRSA02J-223NY	MG RESISTOR	22K 5% 1/10W	
	R 232	NRSA02J-222NY	MG RESISTOR	2.2K 5% 1/10W	
	R 233	NRSA02J-334NY	MG RESISTOR	330K 5% 1/10W	
	R 234	NRSA02J-682NY	MG RESISTOR	6.8K 5% 1/10W	
	R 241	NRSA02J-821NY	MG RESISTOR	820 5% 1/10W	
	R 242	NRSA02J-101NY	MG RESISTOR	100 5% 1/10W	
	R 243	NRSA02J-821NY	MG RESISTOR	820 5% 1/10W	
	R 244	NRSA02J-101NY	MG RESISTOR	100 5% 1/10W	
	R 245	NRSA02J-222NY	MG RESISTOR	2.2K 5% 1/10W	
	R 246	NRSA02J-222NY	MG RESISTOR	2.2K 5% 1/10W	
	R 252	NRSA02J-333NY	MG RESISTOR	33K 5% 1/10W	
	R 253	NRSA02J-223NY	MG RESISTOR	22K 5% 1/10W	
	R 256	NRSA02J-333NY	MG RESISTOR	33K 5% 1/10W	
	R 257	NRSA02J-223NY	MG RESISTOR	22K 5% 1/10W	
	R 281	NRSA02J-333NY	MG RESISTOR	33K 5% 1/10W	
	R 282	NRSA02J-333NY	MG RESISTOR	33K 5% 1/10W	
	R 433	NRSA02J-102NY	MG RESISTOR	1.0K 5% 1/10W	
	R 434	NRSA02J-224NY	MG RESISTOR	220K 5% 1/10W	
	R 435	NRSA02J-222NY	MG RESISTOR	2.2K 5% 1/10W	
	R 436	NRSA02J-524NY	MG RESISTOR	220K 5% 1/10W	
	R 437	NRSA02J-272NY	MG RESISTOR	2.7K 5% 1/10W	
	R 445	NRSA02J-473NY	MG RESISTOR	47K 5% 1/10W	
	R 450	NRS181J-100NY	MG RESISTOR	10 5% 1/8W	

BLOCK NO. 011111

REF.	PARTS NO.	PARTS NAME	REMARKS	SUFFIX
R 784	NRSA02J-102NY	MG RESISTOR	1.0K 5% 1/10W	
R 785	NRSA02J-473NY	MG RESISTOR	47K 5% 1/10W	
R 786	NRSA02J-102NY	MG RESISTOR	1.0K 5% 1/10W	
R 787	QRD141J-472	CARBON RESISTOR	4.7K 5% 1/4W	
R 788	NRSA02J-104NY	MG RESISTOR	100K 5% 1/10W	
R 789	NRSA02J-474NY	MG RESISTOR	470K 5% 1/10W	
R 790	NRSA02J-272NY	MG RESISTOR	2.7K 5% 1/10W	
R 791	NRSA02J-473NY	MG RESISTOR	47K 5% 1/10W	
R 792	NRSA02J-103NY	MG RESISTOR	10K 5% 1/10W	
R 795	NRSA02J-103NY	MG RESISTOR	10K 5% 1/10W	
R 796	NRSA02J-223NY	MG RESISTOR	22K 5% 1/10W	
R 797	NRS181J-ORONY	MG RESISTOR	5% 1/8W	
R 821	QRD141J-102	CARBON RESISTOR	1.0K 5% 1/4W	
R 822	NRSA02J-822NY	MG RESISTOR	8.2K 5% 1/10W	
R 823	NRSA02J-223NY	MG RESISTOR	22K 5% 1/10W	
R 824	NRSA02J-822NY	MG RESISTOR	8.2K 5% 1/10W	
R 825	NRSA02J-223NY	MG RESISTOR	22K 5% 1/10W	
R 826	NRSA02J-153NY	MG RESISTOR	15K 5% 1/10W	
R 827	NRSA02J-473NY	MG RESISTOR	47K 5% 1/10W	
R 828	NRSA02J-223NY	MG RESISTOR	22K 5% 1/10W	
R 829	NRSA02J-223NY	MG RESISTOR	22K 5% 1/10W	
R 830	NRSA02J-472NY	MG RESISTOR	4.7K 5% 1/10W	
R 831	NRS181J-820NY	MG RESISTOR	82 5% 1/8W	
R 941	NRSA02J-102NY	MG RESISTOR	1.0K 5% 1/10W	
R 942	NRSA02J-681NY	MG RESISTOR	680 5% 1/10W	
R 961	NRSA02J-103NY	MG RESISTOR	10K 5% 1/10W	
R 962	NRSA02J-103NY	MG RESISTOR	10K 5% 1/10W	
R 963	NRSA02J-222NY	MG RESISTOR	2.2K 5% 1/10W	
R 964	NRSA02J-473NY	MG RESISTOR	47K 5% 1/10W	
R 969	NRS181J-473NY	MG RESISTOR	47K 5% 1/8W	
S 701	QSW0450-001	DETECT SWITCH		
S 702	QSW0451-001	DETECT SWITCH		
S 901	GSS1201-024L	SLIDE SWITCH		
TU 1	QAU0025-002	TUNER		
X 701	VCX5026-001Z	CRYSTAL		

■ Mechanism board (Head amp./mecha. drive board)

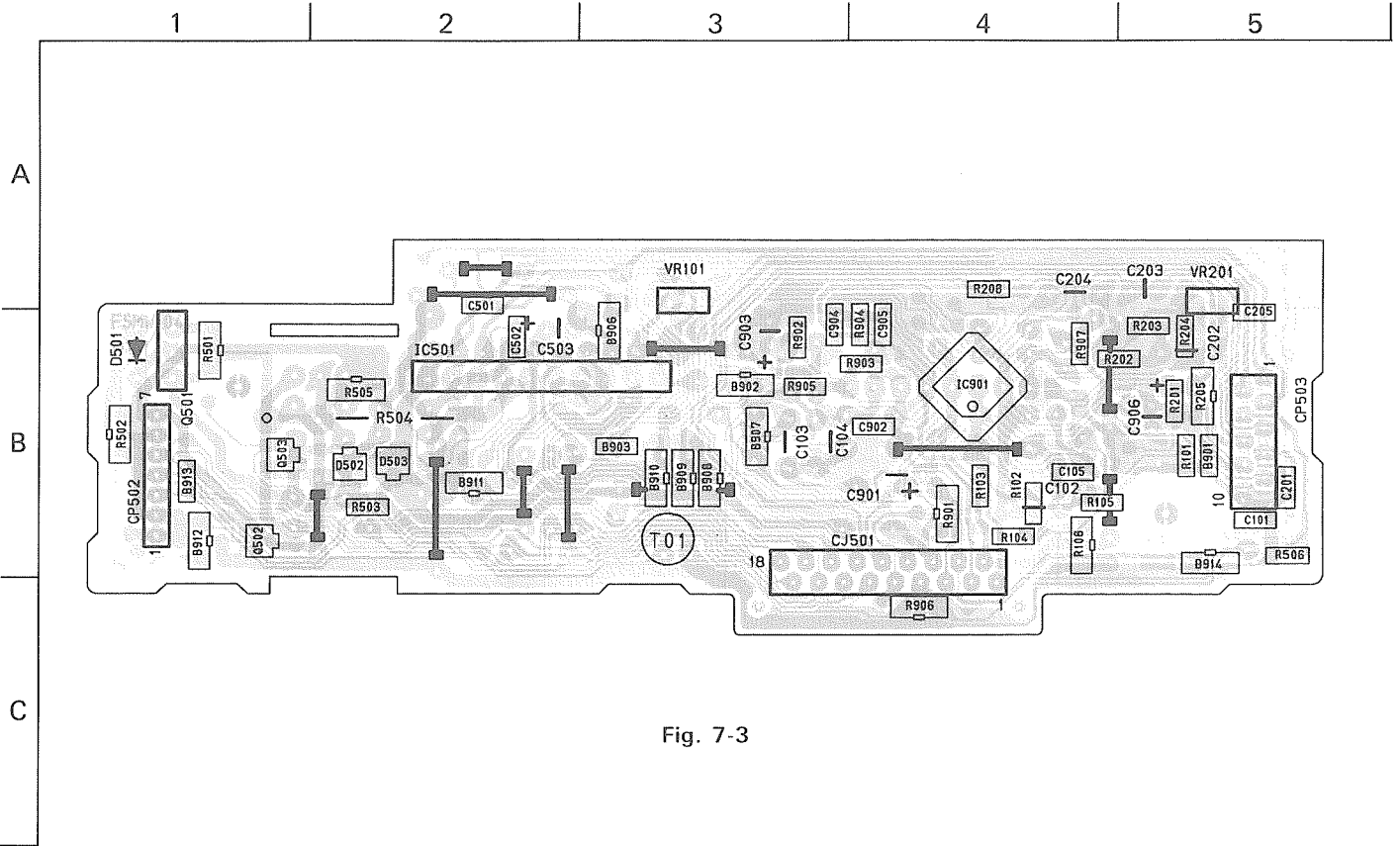

Fig. 7-3

● Mechanism board parts list

BLOCK NO. 03

A	REF.	PARTS NO.	PARTS NAME	REMARKS	SUFFIX
B	901	NRSA02J-OR0NY	MG RESISTOR	B901.B904.B906	
B	902	NRS181J-OR0NY	MG RESISTOR	B902-B903 B908-	
C	101	NCB21HK-471AY	C CAPACITOR	470PF 10% 50V	
C	102	QFV71HJ-103	FILM CAPACITOR	.010MF 5% 50V	
C	103	QEPCL1HM-105ZM	NP.E.-CAPACITOR	1.0MF 20% 50V	
C	104	QFV41HJ-104ZM	FILM CAPACITOR	.10MF 5% 50V	
C	105	NCT21CH-101AY	C CAPACITOR	100PF +50%-10%	
C	201	NCB21HK-471AY	C CAPACITOR	470PF 10% 50V	
C	202	QFV71HJ-103	FILM CAPACITOR	.010MF 5% 50V	
C	203	QEPJ1HM-105ZM	NP.E.-CAPACITOR	1.0MF 20% 50V	
C	204	QFV41HJ-104ZM	FILM CAPACITOR	.10MF 5% 50V	
C	205	NCT21CH-101AY	C CAPACITOR	100PF +50%-10%	
C	501	NCB21HK-103AY	C CAPACITOR	.010MF 10% 50V	
C	502	NCB21HK-104	C CAPACITOR	10MF 10% 25V	
C	503	QEK41CM-106	E.CAPACITOR	10MF 20% 16V	
C	901	QER41CM-226VM	E.CAPACITOR	22MF 20% 16V	
C	902	NCS21HJ-101AY	C CAPACITOR	100PF 5% 50V	
C	903	QEK41HM-474	E.CAPACITOR	.47MF 20% 50V	
C	904	NCB21HK-103AY	C CAPACITOR	.010MF 10% 50V	
C	905	NCB21HK-104	C CAPACITOR	.010MF 10% 25V	
C	906	QEK41CM-226	E.CAPACITOR	22MF 20% 16V	
CJ	501	VMC0314-P18	CONNECTOR		
CJ	503	VMC0314-P10	CONNECTOR		
CP	502	VMC0075-R07	CONNECTOR		
D	501	DSK10C-E	DIODE		
D	502	MA3036(L)X	ZENER DIODE		
D	503	MA3075(M)X	ZENER DIODE		
IC	501	LB1641	IC		
IC	901	CXA2510AQ	IC		
Q	501	ZSB1322(RS)	TRANSISTOR		
Q	502	DTC114EKA-X	TRANSISTOR		
Q	503	DTC114EKA-X	TRANSISTOR		
R	101	NRSA02J-104NY	MG RESISTOR	100K 5% 1/10W	
R	102	NRSA02J-183NY	MG RESISTOR	18K 5% 1/10W	
R	103	NRSA02J-123NY	MG RESISTOR	12K 5% 1/10W	
R	104	NRSA02J-304NY	MG RESISTOR	300K 5% 1/10W	
R	105	NRSA02J-181NY	MG RESISTOR	180 5% 1/10W	
R	108	NRS181J-OR0NY	MG RESISTOR	5% 1/8W	
R	201	NRSA02J-104NY	MG RESISTOR	100K 5% 1/10W	
R	202	NRSA02J-183NY	MG RESISTOR	18K 5% 1/10W	
R	203	NRSA02J-123NY	MG RESISTOR	12K 5% 1/10W	
R	204	NRSA02J-304NY	MG RESISTOR	300K 5% 1/10W	
R	205	NRS181J-181NY	MG RESISTOR	180 5% 1/8W	
R	208	NRSA02J-OR0NY	MG RESISTOR	5% 1/10W	
R	501	NRS181J-473NY	MG RESISTOR	47K 5% 1/8W	
R	502	NRS181J-332NY	MG RESISTOR	3.3K 5% 1/8W	
R	503	NRSA02J-332NY	MG RESISTOR	3.3K 5% 1/10W	
R	504	QRL036J-120	OMF RESISTOR	12 5% 1/3W	
R	505	NRS181J-330NY	MG RESISTOR	33 5% 1/8W	
R	506	NRSA02J-222NY	MG RESISTOR	2.2K 5% 1/10W	
R	901	NRS181J-101NY	MG RESISTOR	100 5% 1/8W	
R	902	NRSA02J-392NY	MG RESISTOR	3.9K 5% 1/10W	
R	903	NRSA02J-233NY	MG RESISTOR	2.3K 5% 1/10W	
R	904	NRSA02J-125NY	MG RESISTOR	1.2M 5% 1/10W	
R	905	NRSA02J-153NY	MG RESISTOR	15K 5% 1/10W	
R	906	NRS181J-103NY	MG RESISTOR	10K 5% 1/8W	
R	907	NRSA02J-183NY	MG RESISTOR	18K 5% 1/10W	
VR	101	QVPA603-333A	SEMI.V.RESISTOR		
VR	201	QVPA603-333A	SEMI.V.RESISTOR		

Switch board

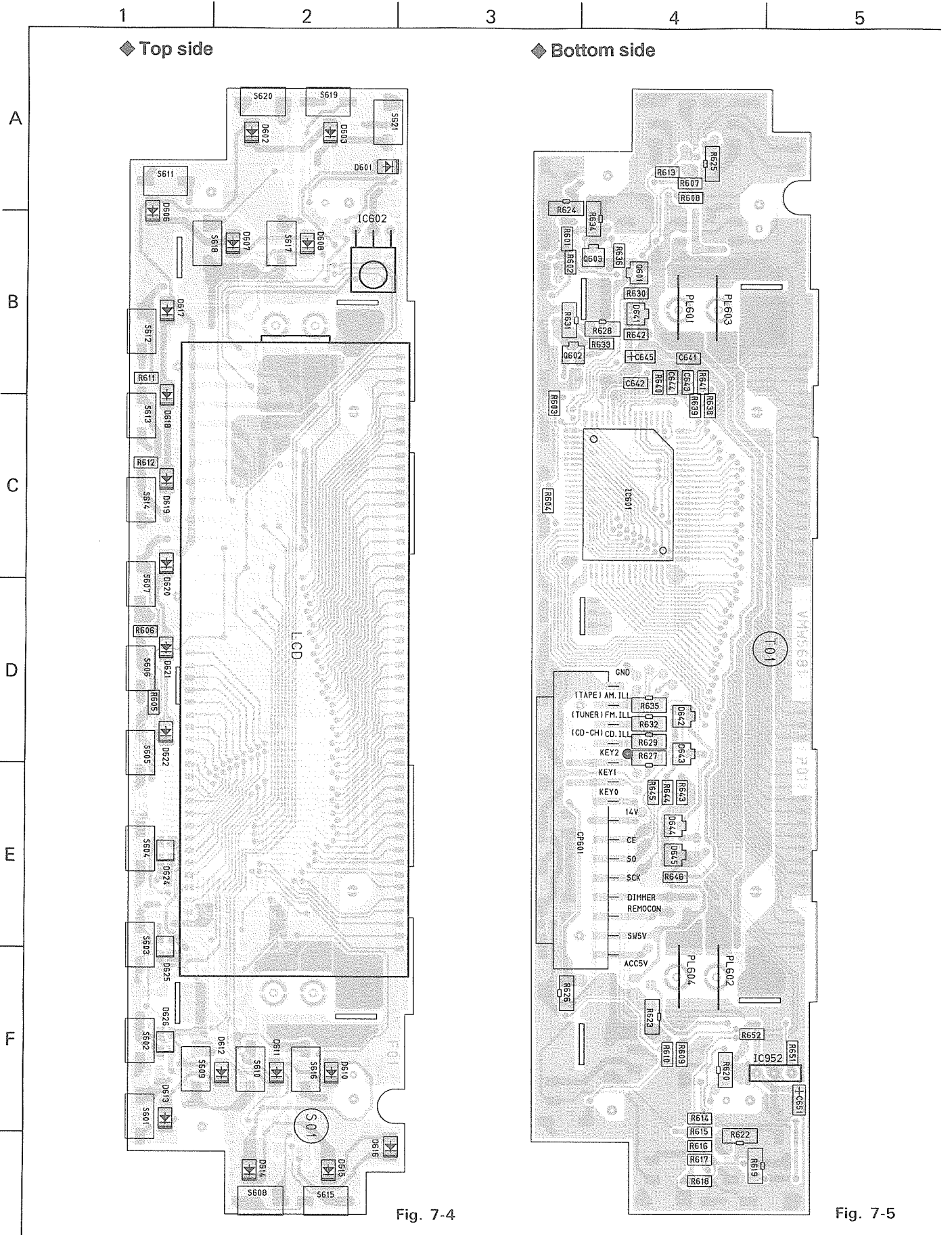

Fig. 7-4

Fig. 7-5

● Switch board parts list

BLOCK NO. 02

BLOCK NO. 02

REF.	PARTS NO.	PARTS NAME	REMARKS	SUFFIX
R 612	NRSA02J-271NY	MG RESISTOR	270 5% 1/10W	
R 613	NRSA02J-821NY	MG RESISTOR	820 5% 1/10W	
R 614	NRSA02J-561NY	MG RESISTOR	560 5% 1/10W	
R 615	NRSA02J-471NY	MG RESISTOR	470 5% 1/10W	
R 616	NRSA02J-391NY	MG RESISTOR	390 5% 1/10W	
R 617	NRSA02J-331NY	MG RESISTOR	330 5% 1/10W	
R 618	NRSA02J-271NY	MG RESISTOR	270 5% 1/10W	
R 619	NRS181J-151NY	MG RESISTOR	150 5% 1/8W	
R 620	NRS181J-271NY	MG RESISTOR	270 5% 1/8W	
R 622	NRS181J-471NY	MG RESISTOR	470 5% 1/8W	
R 623	NRS181J-471NY	MG RESISTOR	470 5% 1/8W	
R 624	NRS181J-331NY	MG RESISTOR	330 5% 1/8W	
R 625	NRS181J-391NY	MG RESISTOR	390 5% 1/8W	
R 626	NRS181J-471NY	MG RESISTOR	470 5% 1/8W	
R 627	NRS181J-471NY	MG RESISTOR	470 5% 1/8W	
R 628	NRS181J-681NY	MG RESISTOR	680 5% 1/8W	
R 629	NRS181J-681NY	MG RESISTOR	680 5% 1/8W	
R 630	NRSA02J-393NY	MG RESISTOR	39K 5% 1/10W	
R 631	NRS181J-681NY	MG RESISTOR	680 5% 1/8W	
R 632	NRS181J-681NY	MG RESISTOR	680 5% 1/8W	
R 633	NRSA02J-393NY	MG RESISTOR	39K 5% 1/10W	
R 634	NRS181J-681NY	MG RESISTOR	680 5% 1/8W	
R 635	NRS181J-681NY	MG RESISTOR	680 5% 1/8W	
R 636	NRSA02J-393NY	MG RESISTOR	39K 5% 1/10W	
R 638	NRSA02J-103NY	MG RESISTOR	10K 5% 1/10W	
R 639	NRSA02J-103NY	MG RESISTOR	10K 5% 1/10W	
R 640	NRSA02J-103NY	MG RESISTOR	10K 5% 1/10W	
R 641	NRSA02J-184NY	MG RESISTOR	180K 5% 1/10W	
R 642	NRSA02J-224NY	MG RESISTOR	220K 5% 1/10W	
R 643	NRSA02J-103NY	MG RESISTOR	10K 5% 1/10W	
R 645	NRSA02J-103NY	MG RESISTOR	10K 5% 1/10W	
R 646	NRSA02J-100NY	MG RESISTOR	10 5% 1/10W	
R 651	NRSA02J-103NY	MG RESISTOR	10K 5% 1/10W	
R 652	NRSA02J-470NY	MG RESISTOR	47 5% 1/10W	
S 601	QS04H11-V09Y	TACT SWITCH		
S 602	QS04H11-V09Y	TACT SWITCH		
S 603	QS04H11-V09Y	TACT SWITCH		
S 604	QS04H11-V09Y	TACT SWITCH		
S 605	QS04H11-V09Y	TACT SWITCH		
S 606	QS04H11-V09Y	TACT SWITCH		
S 607	QS04H11-V09Y	TACT SWITCH		
S 608	QS04H11-V09Y	TACT SWITCH		
S 609	QS04H11-V09Y	TACT SWITCH		
S 610	QS04H11-V09Y	TACT SWITCH		
S 611	QS04H11-V09Y	TACT SWITCH		
S 612	QS04H11-V09Y	TACT SWITCH		
S 613	QS04H11-V09Y	TACT SWITCH		
S 614	QS04H11-V09Y	TACT SWITCH		
S 615	QS04H11-V09Y	TACT SWITCH		
S 616	QS04H11-V09Y	TACT SWITCH		
S 617	QS04H11-V09Y	TACT SWITCH		
S 618	QS04H11-V09Y	TACT SWITCH		
S 619	QS04H11-V09Y	TACT SWITCH		
S 620	QS04H11-V09Y	TACT SWITCH		
S 621	QS04H11-V09Y	TACT SWITCH		

REF.	PARTS NO.	PARTS NAME	REMARKS	SUFFIX
C 641	NCB21HK-103AY	C CAPACITOR	.010MF 10% 50V	
C 642	NCT21CH-221AY	C CAPACITOR	220PF +50%-10%	
C 643	NCB21HK-103AY	C CAPACITOR	.010MF 10% 50V	
C 644	NCB21HK-103AY	C CAPACITOR	.010MF 10% 50V	
C 645	NEF20JM-475RY	TS.E.CAPACITOR	4.7MF 20% 6.3V	
C 651	NEF20JM-475RY	TS.E.CAPACITOR	4.7MF 20% 6.3V	
CP701	GNZ0006-001	CAR CONNECTOR		
D 601	SML-010LT187	LED		
D 602	SML-010PT187	LED		
D 603	SML-010PT187	LED		
D 606	SML-010PT187	LED		
D 607	SML-010PT187	LED		
D 608	SML-010PT187	LED		
D 610	SML-010PT187	LED		
D 611	SML-010PT187	LED		
D 612	SML-010PT187	LED		
D 613	SML-010PT187	LED		
D 614	SML-010PT187	LED		
D 615	SML-010PT187	LED		
D 616	SML-010PT187	LED		
D 617	SML-010PT187	LED		
D 618	SML-010PT187	LED		
D 619	SML-010PT187	LED		
D 620	SML-010PT187	LED		
D 621	SML-010PT187	LED		
D 622	SML-010PT187	LED		
D 624	SML-020MV	LED		
D 625	SML-020MV	LED		
D 626	SML-020MV	LED		
D 641	MA152WK-TX	SI DIODE		
D 642	MA152WA-TX	DIODE		
D 643	MA152WK-TX	SI DIODE		
D 644	MA152WA-TX	DIODE		
D 645	MA152WK-TX	SI DIODE		
IC601	LC75873NE	IC		
IC602	RPM-638CBR-L	IC		
LCD 1	VGL1215-001	LCD		
PL601	QLL0012-001	LAMP		
PL602	QLL0012-001	LAMP		
PL603	QLL0012-001	LAMP		
PL604	QLL0012-001	LAMP		
Q 601	2SB815B7-T-HL	TRANSISTOR		
Q 602	2SB815B7-T-HL	TRANSISTOR		
Q 603	2SB815B7-T-HL	TRANSISTOR		
R 601	NRSA02J-821NY	MG RESISTOR	820 5% 1/10W	
R 602	NRSA02J-561NY	MG RESISTOR	560 5% 1/10W	
R 603	NRSA02J-471NY	MG RESISTOR	470 5% 1/10W	
R 604	NRSA02J-391NY	MG RESISTOR	390 5% 1/10W	
R 605	NRSA02J-331NY	MG RESISTOR	330 5% 1/10W	
R 606	NRSA02J-271NY	MG RESISTOR	270 5% 1/10W	
R 607	NRSA02J-821NY	MG RESISTOR	820 5% 1/10W	
R 608	NRSA02J-561NY	MG RESISTOR	560 5% 1/10W	
R 609	NRSA02J-471NY	MG RESISTOR	470 5% 1/10W	
R 610	NRSA02J-391NY	MG RESISTOR	390 5% 1/10W	
R 611	NRSA02J-331NY	MG RESISTOR	330 5% 1/10W	

8 Exploded view of enclosure assembly and parts list

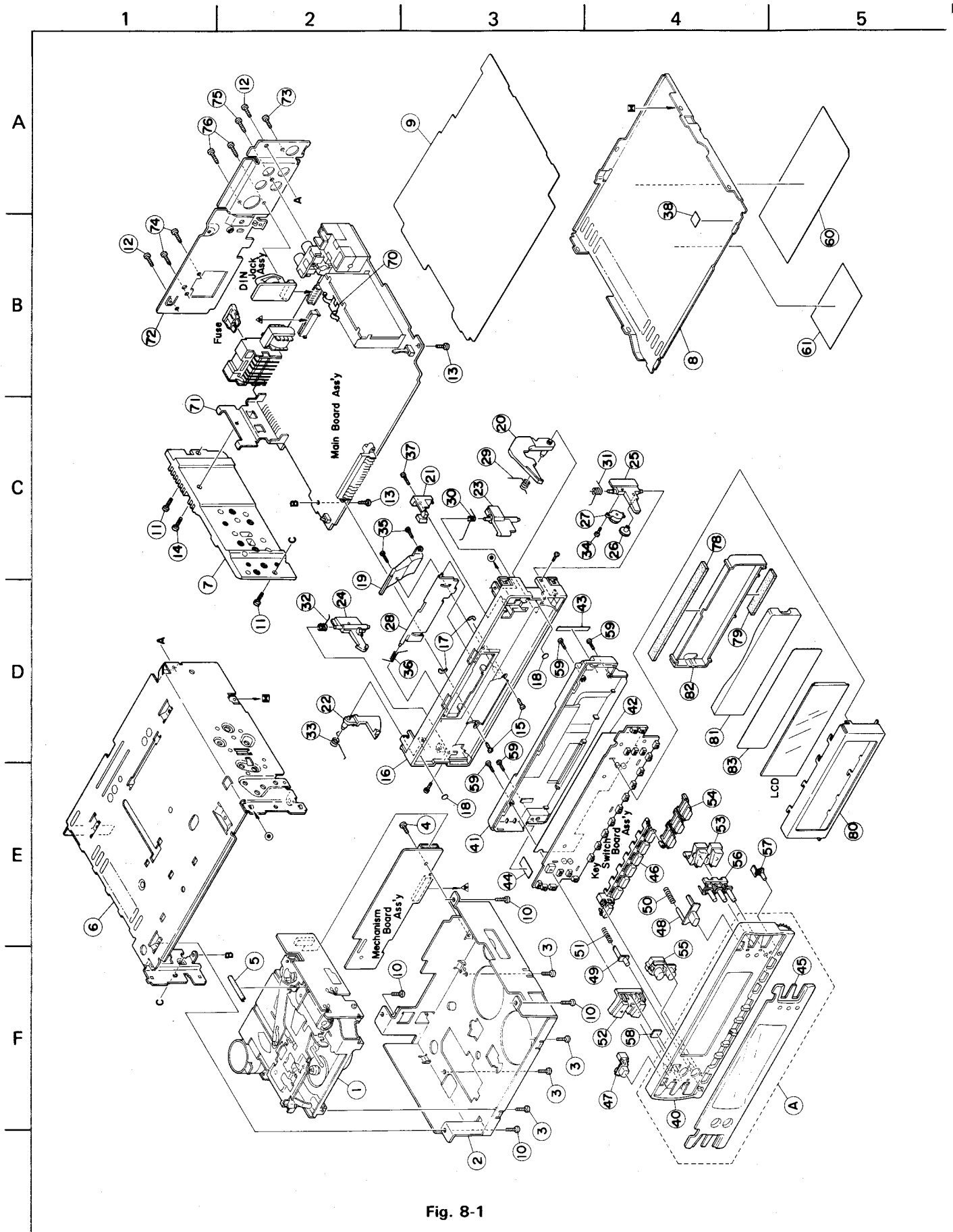

Fig. 8-1

● Enclosure parts list

BLOCK NO. M1111111

△	REF.	PARTS NO.	PARTS NAME	REMARKS	QTY	SUFFIX	CLR
	A	ZCKSRT626J-NPA		NO.40,45	1		
	1	-----	MECHANISM ASS'Y	CDS-522J1	1		
	2	FSKM2003-003	MECHA. BRACKET		1		
	3	SDSP2604Z	SCREW		4		
	4	SDST2604Z	SCREW		1		
	5	VYSA1R4-056	SPACER		1		
	6	FSJC1029-002	TOP CHASSIS		1		
	7	FSMH3001-002	HEAT SINK		1		
	8	FSKM3007-001	BOTTOM COVER		1		
	9	FSMA3004-002	INSULATOR		1		
	10	SDST2604Z	SCREW	CHASSIS+M.BKT	4		
	11	SDST2608Z	SCREW	CHASSIS+SIDE PA	2		
	12	SDST2606Z	SCREW	CHASSIS+REAR BK	2		
	13	SDST2606Z	SCREW	CHASSIS+MAIN PW	2		
	14	SDST2608Z	SCREW	SIDE PANEL+IC B	1		
	15	SDSF2006M	SCREW		2		
	16	VJG1447-001	FRONT CHASSIS		1		
	17	VYTT708-001	SHEET		2		
	18	VYSS2R4-016	SPACER		2		
	19	VJK3707-001	LIGHT LENS		1		
	20	VKS3792-002	OPEN LEVER		1		
	21	VKS3797-001	LOCK LEVER(O.L)		1		
	22	VKS3798-001	RELEASE LEVER		1		
	23	VKS3793-001	LOCK LEVER(TOP)		1		
	24	VKS3794-003	LOCK LEVER(L)		1		
	25	VKS3795-002	LOCK LEVER(R)		1		
	26	VKS5563-001	GEAR		1		
	27	VKZ4786-002	OIL DAMPER		1		
	28	FSJC4003-012	CASSETTE LID		1		
	29	VKW5260-002	T.SPRING	FOR OPEN LEVER	1		
	30	VKW5261-001	T.SPRING	FOR L.LEVER(TOP)	1		
	31	VKW5262-001	T.SPRING	FOR L.LEVER(R)	1		
	32	VKW5263-001	T.SPRING	FOR L.LEVER(L)	1		
	33	VKW5264-004	T.SPRING	FOR RELEASE LEV	1		
	34	SDSF2006M	SCREW	DAMPER+L.LEVER(1		
	35	SPSN1745N	MINI SCREW	L.LENS+F.CHASSI	2		
	36	VKW4947-002	DOOR SPRING	FOR CASSETTE LI	1		
	37	VKZ4777-001	MINI SCREW		1		
	38	VYSR103-048	SPACER		1		
	40	VJG1448-002	FRONT PANEL		1		
	41	VJG1449-001	REAR COVER		1		
	42	VMA4716-001	SHIELD		1		
	43	VYSS1R4-047	SPACER		1		
	44	VYSS1R1-111	SPACER		1		
	45	VJK2217-014	FINDER		1		
	46	FSXP2022-001	PRESET BUTTON	1/2/3/4/5/6	1		
	47	VXP3824-001	POWER BUTTON		1		
	48	VXP3825-001	EJECT BUTTON		1		
	49	VXP3826-001	DETACH BUTTON		1		
	50	VKW3001-330	COMP.SPRING	FOR EJECT BUTTO	1		
	51	VKW3001-330	COMP.SPRING	FOR DETACH BUTT	1		
	52	FSXP3036-001	+/- BUTTON		1		
	53	FSXP3037-001	UP DOWN BUTTON		1		
	54	FSXP2023-003	D.FUNC BUTTON		1		
	55	FSXP3038-001	SND/C. BUTTON		1		
	56	FSXP3039-001	PUSH BUTTON		1		
	57	FSXP4001-001	DISPLAY BUTTON		1		
	58	VKS5578-001	REMOTE LENS		1		
	59	VKZ4777-001	MINI SCREW	FRONT+REAR	4		
	60	VYN3765-S002	NAME PLATE		1		
	61	VND5132-001	AMP SW CAUTION		1		
	70	VMA4652-001SS	EARTH PLATE	FOR TUNER PACK	1		
	71	FSKL4013-001	IC BRACKET		1		
	72	FSKM3008-003	REAR BLACKET		1		
	73	SDST2606Z	SCREW	REAR BKT+ANT JA	1		
	74	SDSP2606Z	SCREW	REAR BKT+15P CN	2		
	75	SDSF3006Z	SCREW	REAR BKT+PIN JA	1		
	76	SDSF2608Z	SCREW	REAR BKT+CD IN	2		
	78	VMZ0152-001	LCD CONNECTOR		1		
	79	VMZ0153-001	LCD CONNECTOR		1		
	80	VKM3912-002	LCD CASE		1		
	81	VJK3708-002	LCD LENS		1		
	82	VKS2283-001	LENS CASE		1		
	83	VYTT702-001	LCD FILTER		1		
		FUSE QMFZ021-100-J1	FUSE		1		
		LCD VGL1215-001	LCD		1		

9 Exploded view of mechanism assembly and parts list

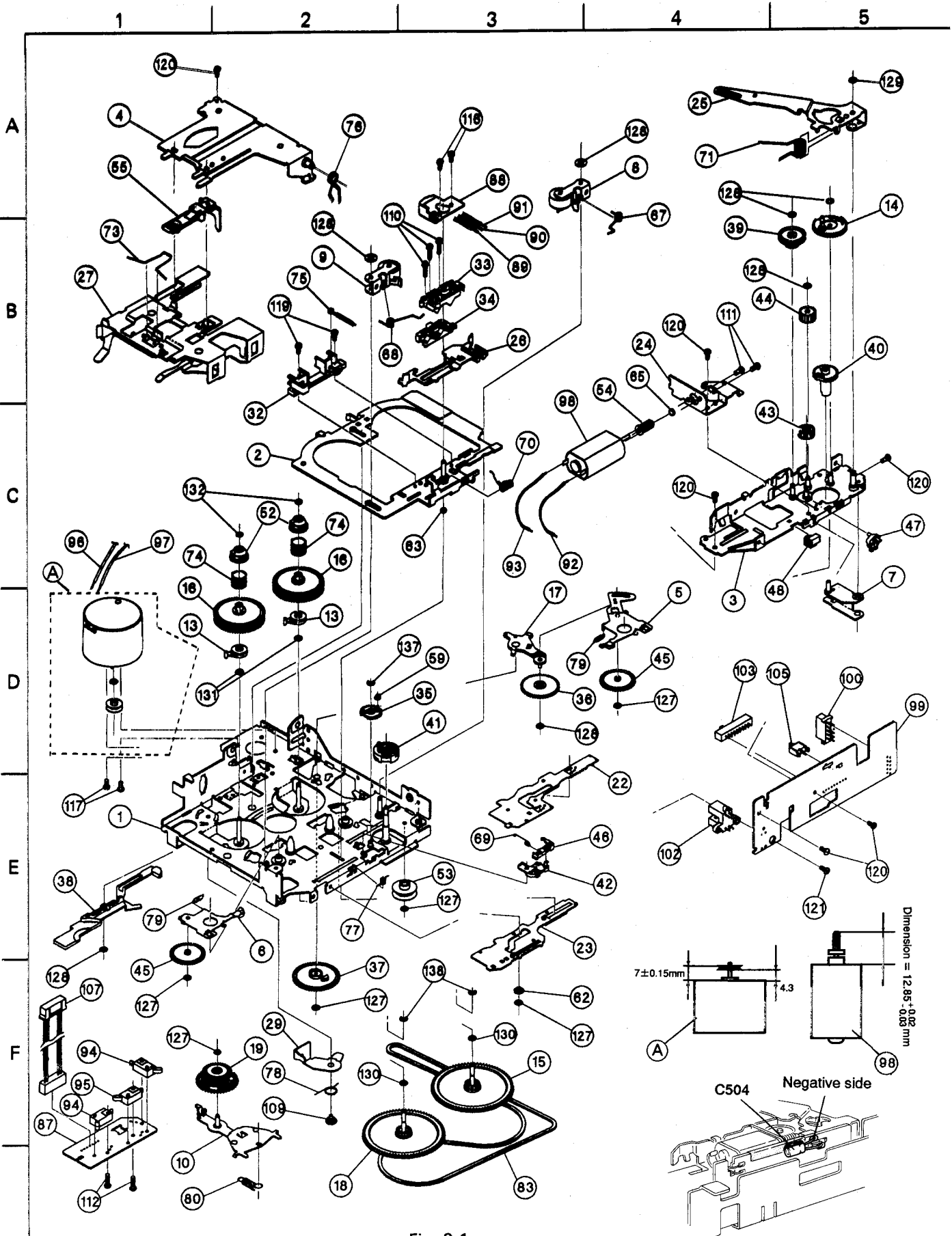

Fig. 9-1

The capacitor C504 is not included in the mechanism unit.

● Mechanism parts list

BLOCK NO.

△	REF.	PARTS NO.	PARTS NAME	REMARKS	QTY	SUFFIX	CLR
	A	100367057S-SA3	DC MOTOR ASS'Y	NO.64,104,126	1		
	1	1-0522-6001S	CHASSIS ASS'Y		1		
	2	1-0522-6002S	HEAD PLATE ASSY		1		
	3	1-0522-6003S	SUB CHASSIS ASY		1		
	4	X-0522-1004S	HOLDER ARM ASSY		1		
	5	X-0522-1006S	T.U.ARM(F)ASS'Y		1		
	6	X-0522-1007S	T.U.ARM(R)ASS'Y		1		
	7	X-0522-1010S	SET ARM ASS'Y		1		
	8	X-0522-1019S	PINCH ARM(F)ASY		1		
	9	X-0522-1020S	PINCH ARM(R)ASY		1		
	10	X-0522-1022S	FR ARM ASS'Y		1		
	13	X-0522-2008S	DETECT ARM ASSY		2		
	14	X-0522-2010S	LOAD GEAR ASS'Y		1		
	15	X-0522-2016-2S	FLYWHEEL ASY(FJ		1		
	16	X-0522-2018S	REEL TABLE ASSY		2		
	17	X-0522-2020S	REDUCT.GEAR ARM		1		
	18	X-0522-2021-2S	FLYWHEEL ASY(RJ		1		
	19	X-0052-2001S	F.R. GEAR ASS'Y		1		
	22	1-0522-1008S	DIR.PLATE		1		
	23	1-0522-1009S	FF/REW PLATE		1		
	24	1-0522-1012S	MOTOR BRACET		1		
	25	1-0522-1013S	LOAD ARM		1		
	26	1-0522-1014S	SHIFT CAM LINK		1		
	28	1-0522-1017S	CASSETTE HOLDER		1		
	29	1-0522-1016S	METAL DETECT LE		1		
	32	1-0522-2001S	TAPE GUIDE		1		
	33	1-0522-2002S	HEAD BRACKET		1		
	34	1-0522-2003S	HEAD SHIFT CAM		1		
	35	1-0522-2004-03S	SELECT GEAR		1		
	36	1-0522-2005S	REDUCTION GEAR		1		
	37	1-0522-2006S	DETECT GEAR		1		
	38	1-0522-2007S	DETECTOR		1		
	39	1-0052-2012S	WORM GEAR		1		
	40	1-0522-2011S	MODE GEAR		1		
	41	1-0522-2012S	MODE GEAR(2)		1		
	42	1-0522-2013S	GEAR LATCH		1		
	43	1-0522-2014S	IDLE GEAR(1)		1		
	44	1-0522-2015S	IDLE GEAR(2)		1		
	45	1-0522-2017S	TU GEAR		2		
	46	1-0522-2019S	RACHET		1		
	47	1-0522-2022S	SW ACTUATER		1		
	48	1-0522-2024S	PWB STAY		1		
	52	1-0052-2004S	REEL DRIVER		2		
	53	1-0052-2006S	IDLE PULLEY		1		
	54	1-0052-2010S	WORM		1		
	55	1-0052-2032S	CATCH(K)		1		
	59	1-0522-3005S	SELECT GEAR COL		1		
	62	1-0052-3028S	H.B. ROLLER(L)		1		
	63	1-0052-3029S	H.B. ROLLER(S)		1		
	65	1-0522-3026S	WORM COLLAR		1		
	67	1-0522-4001S	PINCH ARM(F)SPG		1		
	68	1-0522-4002S	PINCH ARM(R)SPG		1		
	69	1-0522-4003S	GEAR LATCH SPG		1		
	70	1-0522-4004S	HEAD SPG		1		

BLOCK NO. M2MM I I

REF.	PARTS NO.	PARTS NAME	REMARKS	QTY	SUFFIX	CLR
71	1-0522-4006S	LOAD ARM SPG		1		
73	1-0522-4008S	CATCH SPG		1		
74	1-0522-4010S	REEL DRIVER SPG		2		
75	1-0522-4011S	DASH SPG		1		
76	1-0522-4014S	HOLDER ARM SPG		1		
77	1-0522-4016S	HOLD SPG		1		
78	1-0522-4009S	METAL DETECT SP		1		
79	1-0522-4017S	TU ARM SPG		2		
80	1-0522-4015S	FR ARM SPG		1		
83	1-0052-5022S	BELT		1		
87	1-0522-7002S	REEL POARD		1		
88	1-0522-7003S	2CH HEAD	P-7742-HG	1		
89	1-0522-7004S	HEAD WIRE(A)		1		
90	1-0522-7005S	HEAD WIRE(B)		1		
91	1-0522-7006S	HEAD WIRE(C)		1		
92	1-0052-7082-0S	SUB MOTOR WIRE	RED	1		
93	1-0052-7082-2S	SUB MOTOR WIRE	BLACK	1		
94	1-0522-7010S	LEAF SWITCH	MLS-2	2		
95	1-0522-7011S	LEAF SWITCH	MLS-4	1		
96	1-0522-7013S	MOTOR WIRE	RED	1		
97	1-0522-7014S	MOTOR WIRE	BLACK	1		
98	1-0522-7018S	SUB MOTOR	PPN13EB10C	1		
99	1-0522-7022S	HEAD PWB(JV)		1		
100	1-0522-7024S	CONNECTOR 10P	TKC-F10X-K1	1		
102	X-0052-7040S	PHOTO COUPLER		1		
103	1-0036-7007-1S	SLIDE SWITCH	SLD-32-710S	1		
105	1-0056-7011S	SWITCH	SW-112-5	1		
107	1-0052-7013S	JOINT WIRE (7P)		1		
109	1-0522-5002S	SPECIAL SCREW		1		
110	1-0522-5003S	AZIMUTH SCREW		3		
111	1-0052-5023S	MOTOR SCREW	M2X2.5	2		
112	1-0101-5006S	SCREW PLAIN	M1.7X7	2		
116	1-0522-5005S	SPECIAL SCREW(2		2		
117	2-1032-0022-C2S	MACHINE SCREW	M2X2.2	2		
119	1-0522-5006S	SPECIAL SCREW(3		2		
120	2-1332-0030-C1S	SCREW	M2X3	6		
121	2-1382-0050-C2S	PLAIN	M2X5	1		
127	2-1812-0030-D2S	POLY WASHER(S)	1.2X3X0.25	6		
128	2-1816-0032-D2S	POLY WASHER(S)	1.6X3.2X0.25	7		
129	2-1816-0032-52S	PSW-S	1.6X3.2X0.5	1		
130	2-1821-0032-D1S	PSW	2.1X3.2X0.25	2		
131	2-1821-0040-D1S	POLY WASHER	2.1X4X0.25	2		
132	1-0053-5005S	LMW-S	1.5X3.2X0.25	2		
137	2-1711-5040-16S	E RING	1.5	1		
138	2-1711-6032-96S	E RING	1.6X3.2X0.3	2		
C 504	QER41CM-106	E.CAPACITOR	10MF 20% 16V	1		

10 Illustration of packing and parts list

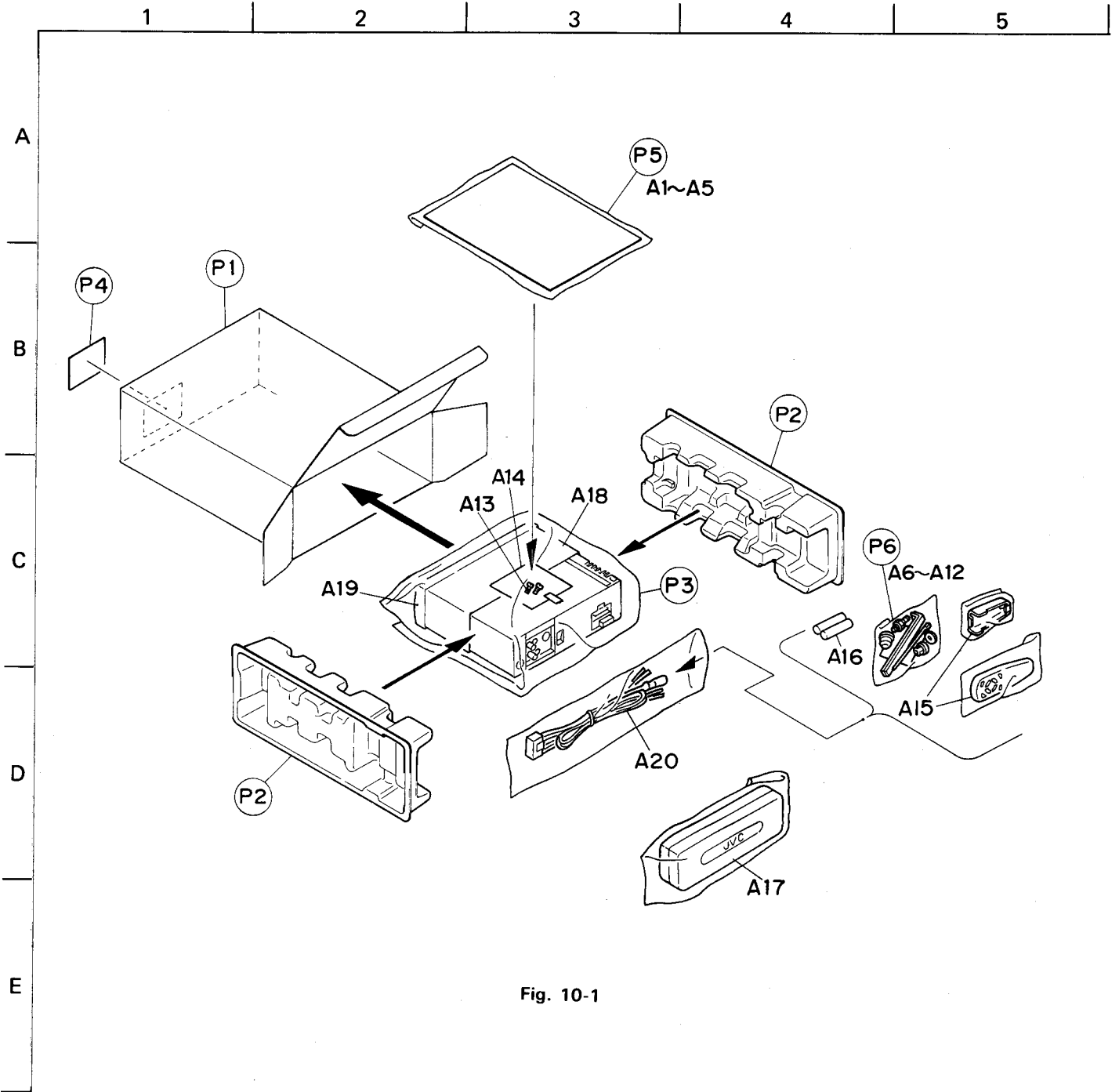

Fig. 10-1

● Packing parts list

BLOCK NO. M3MM

△	REF.	PARTS NO.	PARTS NAME	REMARKS	QTY	SUFFIX	CLR
P	1	VPC3765-S003	CARTON		1		
P	2	VPH1712-001	PAPER CUSHION		2		
P	3	VPE3005-066	POLY BAG	SET	1		
P	4	-----	CARTON LABEL	046838103568	1		
P	5	QPGA017-02505	POLY BAG		1		
P	6	QPGA008-01205	POLY BAG		1		

● Accessories

BLOCK NO. M3MM

REF.	PARTS NO.	PARTS NAME	REMARKS	QTY	SUFFIX	CLR
A 1	VNN3765-631S	INSTRUCTIONS		1		
A 2	VNC2400-130S	INST MANUAL		1		
A 3	VNC2400-090	CAUTION SHEET		1		
A 4	BT-51009-2S	WARRANTY CARD		1	J	
	BT-52001-3S	WARRANTY CARD		1	C	
A 5	BT-20071B	SVC CENTER LIST		1	C	
	BT-20137	SERVICE NETWORK		1	J	
A 6	VKZ4027-002	PLUG NUT		1		
A 7	VKH4871-001	MOUNT BOLT		1		
A 8	VKZ4328-001	LOCK NUT		1		
A 9	WNS5000Z	WASHER		1		
A 10	FSKL4010-002	HOOK		2		
A 11	QHX2075-001	WIRE CLAMP		1		
A 12	VYTT682-001	DOUBLE FACE		1		
A 13	VKZ4777-001	MINI SCREW	THEFT PREVENTIO	2		
A 14	VND5114-001	SHEET	THEFT PREVENTIO	1		
A 15	VGR0047-102	REMOCON UNIT		1		
A 16	R03UPTT-2STS	BATTERY		2		
A 17	FSJB3001-00A	HARD CASE		1		
A 18	FSKM2004-001	MOUNTING SLEEVE		1		
A 19	FSJD2019-002	TRIM PLATE		1		
A 20	QAM0012-001	16P CORD ASS'Y		1		
KIT 1	KSRT626J-SCREW1	SCREW PARTS KIT	NO.A6-A12	1		
KIT 2	KSRT626J-SCREW2	SCREW PARTS KIT	NO.A13-A14	1		

● Accessories parts

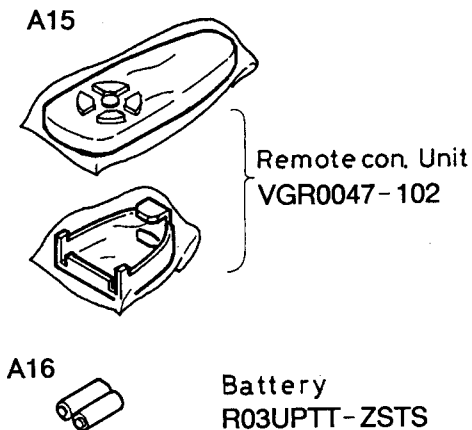

◆ SCREW KIT 1

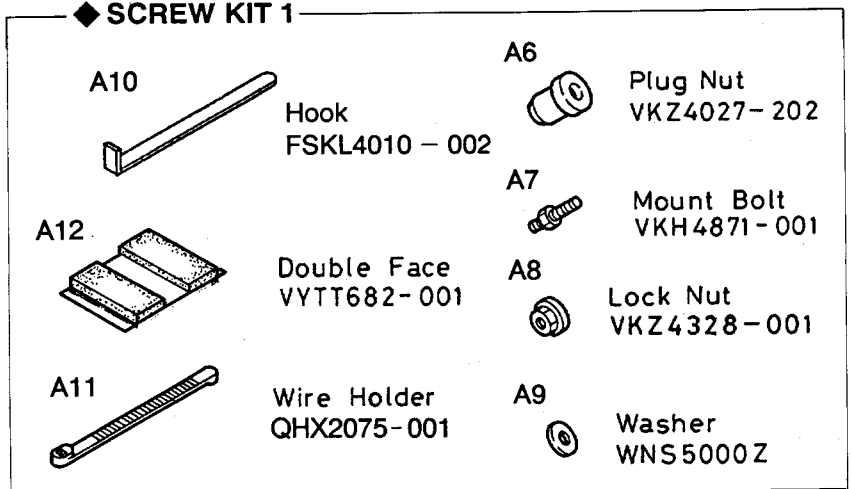

◆ SCREW KIT 2

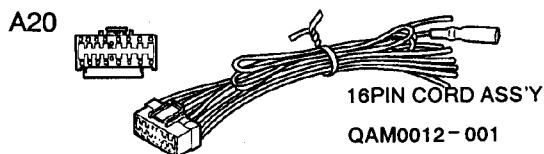
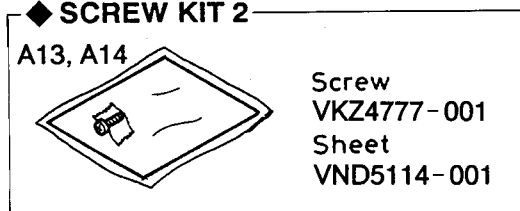

JVC

VICTOR COMPANY OF JAPAN, LIMITED
AUDIO PRODUCTS DIVISION 10-1, 1-chome, Ohwatari-machi, Maebashi-city, Japan